

SONOS

Beam

Product Guide



THIS DOCUMENT CONTAINS INFORMATION THAT IS SUBJECT TO CHANGE WITHOUT NOTICE.

No part of this publication may be reproduced or transmitted in any form or by any means, electronic or mechanical, including but not limited to photocopying, recording, information retrieval systems, or computer network without the written permission of Sonos, Inc. Sonos and all other Sonos product names and slogans are trademarks or registered trademarks of Sonos, Inc. Sonos Reg. U.S. Pat. & Tm. Off.

Sonos products may be protected by one or more patents. Our patent-to-product information can be found here:

sonos.com/legal/patents

AirPlay®, Apple Music™, FairPlay®, iPad®, iPhone®, iPod®, iTunes®, and OS X®, are trademarks of Apple Inc., registered in the U.S. and other countries.

Works with Apple Airplay.

Windows® is a registered trademark of Microsoft Corporation in the United States and other countries.

Android™ is a trademark of Google, Inc.

Manufactured under license from Dolby Laboratories. Dolby and the double-D symbol are trademarks of Dolby Laboratories.

Amazon, Kindle, Kindle Fire, Echo, Alexa, and all related logos are trademarks of Amazon.com, Inc. or its affiliates.

The terms HDMI and HDMI High-Definition Multimedia Interface, and the HDMI logos are trademarks or registered trademarks of HDMI Licensing LLC in the United States and other countries.

Sonos uses MSNTP software, which was developed by N.M. Maclaren at the University of Cambridge.

© Copyright, N.M. Maclaren, 1996, 1997, 2000; © Copyright, University of Cambridge, 1996, 1997, 2000.

All other products and services mentioned may be trademarks or service marks of their respective owners.

June 2018

©2004-2018 by Sonos, Inc. All rights reserved.

Sonos Beam

Beam is a smart, compact soundbar for your TV with immersive, theater-quality sound.

- Play anything—music, TV, movies, podcasts, radio, audiobooks and video games.
- Perfect size to wall-mount above or below your TV, or place on a credenza.
- **Voice control** so you can use it hands-free.
- Quick and easy setup, with only one cable to connect to your TV.
- Expandable. Connect Sonos speakers wirelessly to create a home sound system.



New to Sonos?

Download the app from the app store on your mobile device. Open the app and we'll guide you through setup. If you're using a computer, get the app at www.sonos.com/support/downloads.

For the latest system requirements and compatible audio formats, go to <http://faq.sonos.com/specs>.

Already have Sonos?

You can easily add new speakers anytime (up to 32).

Just plug in the speaker and tap **...** > **Add Speakers**.

If you're using a computer, go to **Manage** > **Add a Player or Sub**.

What's in the box

Carefully unpack the box. There are a few audio cables inside. You'll use the HDMI cable—during setup, we'll see if you need the optical adapter too.

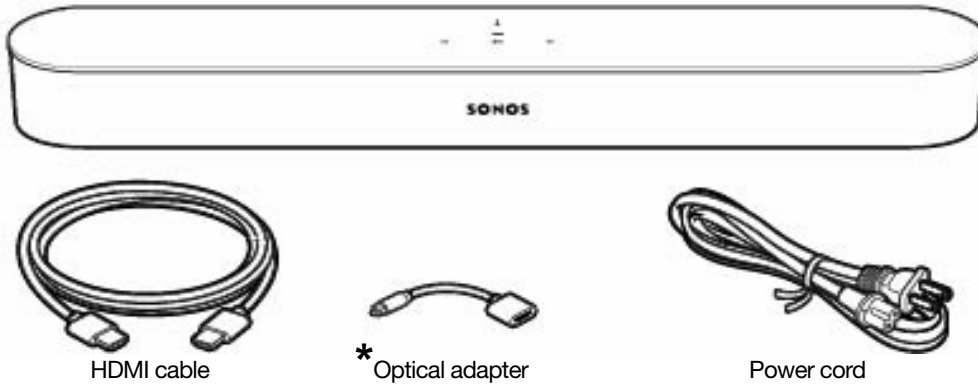

*The optical adapter will only be used if your TV doesn't have an HDMI ARC port.

What you need

- **TV** with an **HDMI ARC** port (preferred) or **optical digital audio OUT** port.
- **Mobile device** (it's easier) or **computer** connected to your **Wi-Fi**. You'll need this for setup. Have your network name and password ready. See **Your home network** for more detail.
- The **Sonos app** to guide you through setup (install it on the device you're using for setup).

Choose a location

You can mount Beam to a wall above or below your TV or place it on a credenza.

Placed on a credenza

- Place horizontally on a stable and level surface at least 2" (50mm) from TV.
- Don't place vertically or on its side.
- Don't block the TV's IR sensor.
- If put on a shelf, place at the front and keep 2" (minimum) clearance on both sides for best sound quality.
- Keep 1" (25mm) space (minimum) above Beam so you can reach the touch controls.
- For best sound quality, keep both ends of Beam at least 1' (30cm) from a wall or other obstruction.

Wall mounted

- Use the Beam wall mount kit. You can buy it on www.sonos.com. Follow the instructions in the kit.
- Keep 1" (25mm) space (minimum) above Beam so you can reach the touch controls.
- If you're mounting above the TV, make sure you can reach the touch controls.
- For best sound quality, keep both ends of Beam at least 1' (30cm) from a wall or other obstruction.

Connect the cables

Before you start

1. Disconnect existing home theater or surround sound equipment from your TV.
2. Connect any external devices, such as a cable box or DVD player, directly to your TV.

Connect the power cord

1. Insert the power cord firmly into Beam's AC (mains) power port until it is fully connected.

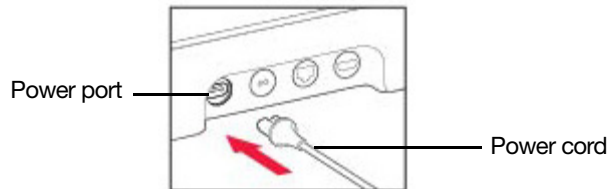

2. Plug the other end of the power cord into an AC (mains) power source.

Caution: Use only the supplied power cord (using a third-party power cord will void your warranty).

Connect Beam to your TV

Use the HDMI cable to connect the soundbar to your TV. You may need the optical adapter too (the app lets you know).

1. Fully insert the HDMI cable into Beam's HDMI port.

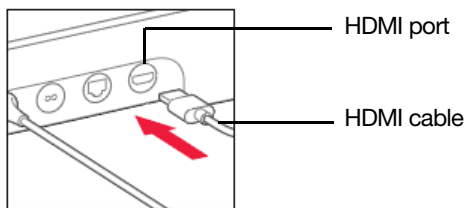

2. Connect the HDMI cable to your TV. You have two choices:
 - **If your TV has an HDMI ARC port**, connect the HDMI cable directly to the TV's HDMI ARC port.
 - **If your TV doesn't have an HDMI ARC port**, attach the optical adapter to the HDMI cable and connect it to the TV's optical digital OUT port.

If your TV has an HDMI ARC port

HDMI ARC is a special port that looks like a standard HDMI port. Although they look the same, if you connect to a standard HDMI port, *you won't hear sound*.

1. On your TV's **audio OUT** panel, look for an **HDMI ARC** port.
It may be on the back or side of your TV.
You'll know it's an ARC port if you see the word "ARC" on the label.

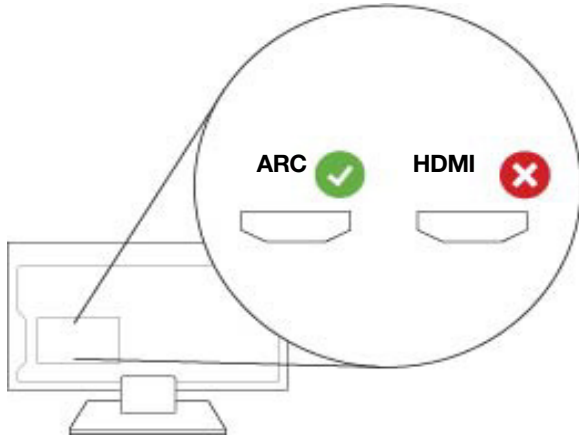

2. Connect the HDMI cable to the TV's **HDMI ARC** port.

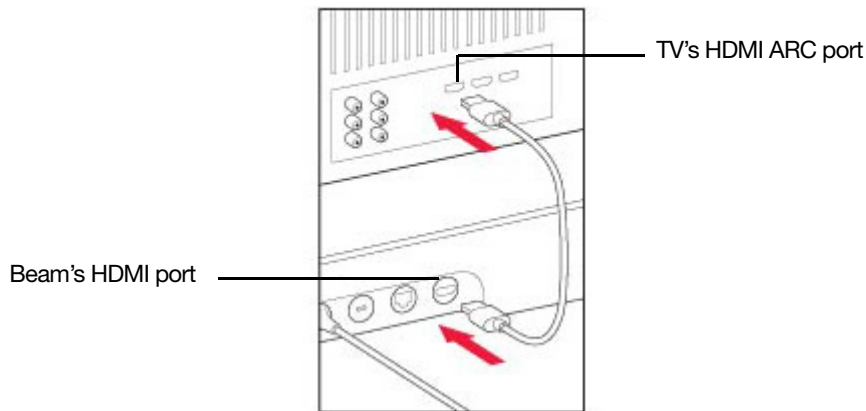

Note: If you can't find the word "ARC" on the label, it isn't the correct port, see **if your TV doesn't have an HDMI ARC port.**

If your TV doesn't have an HDMI ARC port

You'll need the optical adapter.

1. Remove the protective cap from the optical adapter.
2. Attach the optical adapter to the HDMI cable.

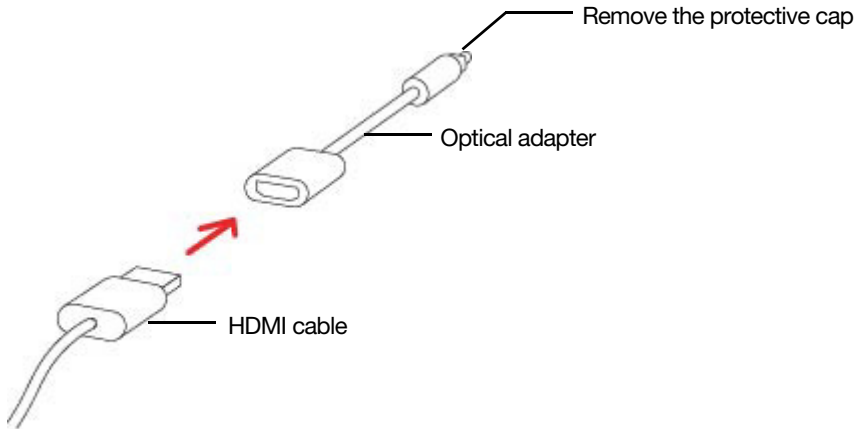

3. Connect the optical adapter to the TV's **optical digital OUT** port.

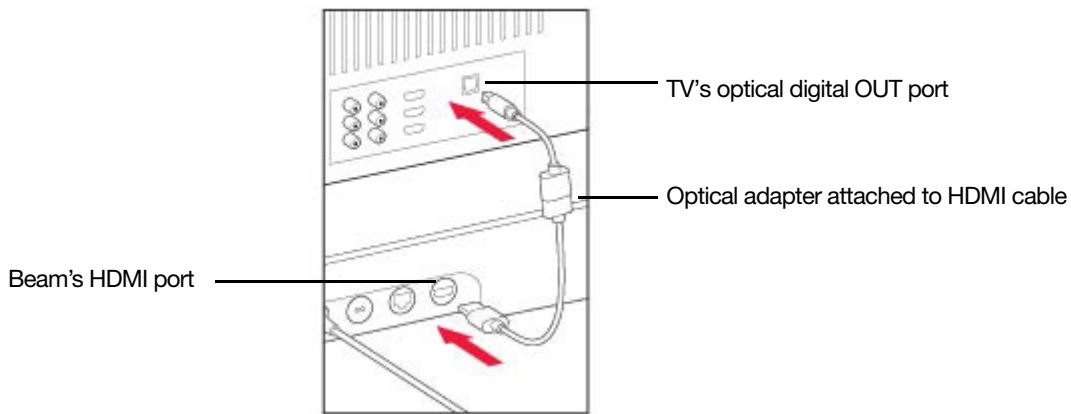

Note: The optical adapter's port is "D-shaped" — make sure the connector aligns correctly into the port. Inserting the adapter incorrectly may damage the cable.

Explore Beam

Swipe, touch, tap, or ask—with Beam you’ve got choices on how to control sound.

- Use the touch controls—touch or swipe across the controls.
- Voice control—Set it up and use your voice to turn the TV on or off, adjust the volume, or play music.
- Use the app.
- Use your TV remote control.

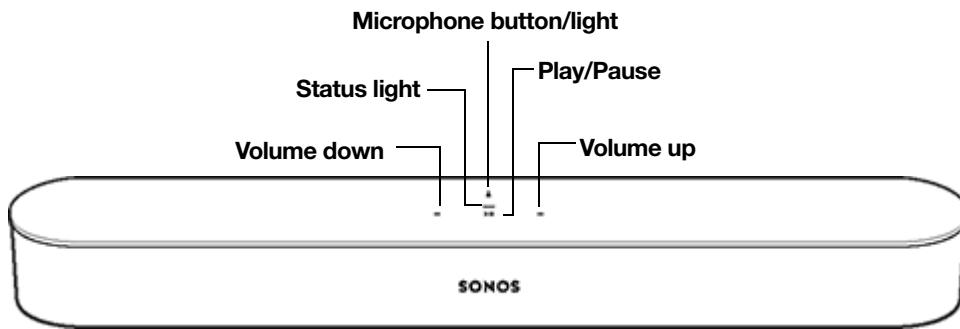

Note: Refer to the *Sonos App for Mobile Devices Product Guide* for more information on using the app.

Touch controls

⏮	Volume	<ul style="list-style-type: none"> • Touch for small adjustments or touch and hold to quickly change the volume: • Volume up (right); Volume down (left). <p>Note: You can also use the app, Alexa, or remote control.</p>
>	Play/Pause	Touch to <u>Play or pause sound.</u>
⏮ > ⏭	Next/Previous track (Music only)	Swipe left or right across controls. Note: This doesn't work with radio stations.
🎤	Microphone button	Turns the microphone on (light on) or off (light off). Note: You'll need to install a voice service to activate the microphone.

Status lights

Speaker status	<ul style="list-style-type: none"> • Normal operation: Solid white (dim). • Listening or replying: Solid white (bright). • Thinking: Flashing white. <p>For more information, see http://faq.sonos.com/led.</p>
Microphone	Shows whether the microphone is on (light on) or off (light off).

Connector panel

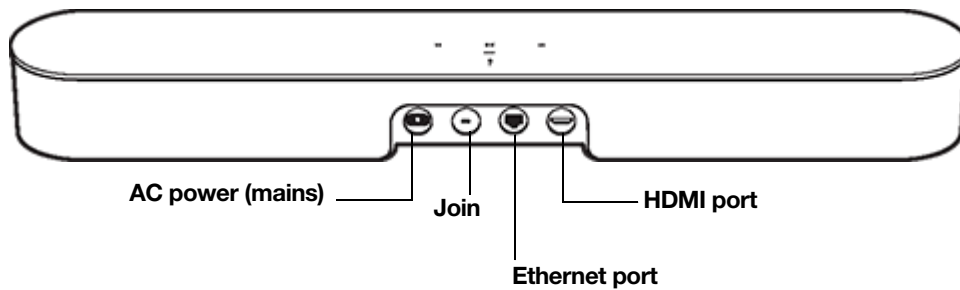

Join button	Press Join to connect during setup.
Ethernet port	Use an Ethernet cable if you want to connect to a router, computer, or network-attached storage (NAS) device (optional).
AC power (mains) port	Use only the supplied power cord (using a third-party power cord will void your warranty). Note: Insert the power cord firmly until it is flush with the speaker.
HDMI port	Use to connect the soundbar to your TV.

Voice control

To use Alexa with Sonos, you'll need the Alexa app with the Sonos skill enabled—if you don't have it, we'll guide you through it when you add a voice service.

Add a voice service

1. Open the Sonos app on your mobile device.
2. Tap **...** > **Voice Services** and select the voice service.
 - You'll make changes in both the Sonos and Alexa apps—we'll guide you through it.
 - You'll need your Sonos account info. If you can't remember it, tap **...** > **Settings** > **Sonos Account**.

(Sonos doesn't support Alexa voice calling.)

Note: Over time we'll add more voice services and skills. Voice control is not supported in every country yet—this feature will be available as soon as Sonos and a voice service launch together in your region.

Change the wake word's language

1. Tap **...** > **Settings** > **Room Settings**.
2. Choose the room with Alexa and change the wake word's language.

Remove a voice service

1. Tap **...** > **Settings** > **Room Settings**.
2. Choose the room with Alexa.
3. Tap **Amazon Alexa** and remove Amazon Alexa from the room.

Turn the microphone on

Touch  to turn the microphone on and off. (If you don't have a voice service installed, the microphone is inactive.)

When the microphone light is on, voice control is on and Alexa is ready to respond. When the microphone light is off, voice control is off.

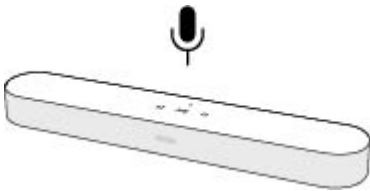

If you've installed a voice service and the microphone is off, you can still use voice commands. Just press and hold  while talking to Alexa—no need to start with a wake word. When you release the mic button, voice control turns off again.

Adjust TV and sound settings

Use the app to change sound settings or modify the way your home theater speaker works with your TV. Refer to the *Sonos App for Mobile Devices Product Guide* to get more information about using the Sonos app.

Note: You can also use the Sonos app for Mac or PC.

TV Dialog Settings

If TV audio is out of sync with video, use the app to adjust the audio delay (lip sync).

1. Tap **...** > **Settings** > **Room Settings** and select the room.
2. Tap **Advanced Audio** > **TV Dialog Settings**.
3. Drag your finger across the **Audio Delay (Lip Sync)** slider to increase or decrease the sound delay.

TV Autoplay

Turn on TV Autoplay (default) so audio plays directly through the home theater speaker when you turn on your TV.

If music is playing when you turn on the TV, the music stops and the home theater speaker switches to TV audio.

1. Tap **...** > **Settings** > **Room Settings** and select the room.

2. Tap **TV Setup and Control** > **TV Autoplay**.

If the home theater speaker is part of a group when the TV is turned on, it drops from the group (default).

3. Select **On** or **Off**.

Ungroup on Autoplay

You can include your home theater speaker in a group if you're playing music in a group of rooms.

Turn on **Ungroup on Autoplay** to ungroup your home theater speaker when you turn on the TV (default).

1. Tap **...** > **Settings** > **Room Settings** and select the room.

2. Tap **TV Setup and Control** > **Ungroup on Autoplay**.

Enhance TV sound

When you're watching TV, the Now Playing screen in the app includes sound enhancement features. These features are only visible when you're looking at the room where your home theater speaker is located.

Speech Enhancement

Makes TV dialog easier to hear.

Tap  on the Now Playing screen to turn on or off.

Night Sound

Enhances quiet sounds and reduces the intensity of loud sounds. Turn on to reduce the volume while still experiencing proper balance and range.

Tap  on the Now Playing screen to turn on or off.

Tune your room with Trueplay™

Every room is different. With Trueplay tuning, you can put your speakers wherever you want. Trueplay analyzes room size, layout, décor, speaker placement, and any other acoustic factors that can impact sound quality. Then it adjusts how each woofer and tweeter produces sound in that room (works on mobile devices running iOS 8 or later).

Tap **...** > **Settings** > **Room Settings**. Pick a room and tap **Trueplay Tuning** to get started.

Note: Trueplay tuning isn't available if VoiceOver is enabled on your iOS device. If you want to tune your speakers, first turn VoiceOver off in your device settings.

Program your remote control

If you've connected to Beam using the optical adapter, you may need to program your remote control. If connected with the optical adapter, Beam supports IR remote controls.

You can program a different remote control any time.

1. Open the app and tap **...** > **Settings** > **Room Settings**.

Note: You can also use the Sonos app for Mac or PC to program your remote.

2. Choose the room.

3. Tap **TV Setup and Control** > **Remote control setup**.

Note: If you've connected to Beam using the optical adapter, some TVs show unnecessary messages when you adjust the volume. You may be able to turn these off. See [Turn off volume control messages](#).

Additional room settings

Tap **⋮** > **Settings** > **Room Settings** to see more room settings you can change, such as:

- Recalibrate audio (Android)
- Turn off the speaker status light
- Disable speaker touch controls
- Change room names
- Adjust EQ

Play music

Beam can stream music whether the TV is on or off. If **TV Autoplay** is set to *On*, the music stops and switches to TV audio whenever you turn on the TV.

- **Radio by TuneIn.** Select from more than 100,000 free internet radio stations, podcasts, and shows.
- **Music services.** Explore and manage your music services—add your own or try something new.
- **Music stored on your mobile device.** Play music you've downloaded to your phone or tablet.
- **Music library.** Play music stored on your computer or any Network-Attached Storage (NAS) device.

For a full list of the music choices available in your country, go to www.sonos.com/music. For more information about playing music, check out our mobile app product guide at www.sonos.com/guides.

Play or pause sound

Touch **>||** to start or stop the audio.

- **TV**—When the TV is on, touch **>||** to toggle the sound on and off.
- **Music**—When the TV is off, touch **>||** to restart music.

Add music that's playing in another room

Press and hold **>||** on any Sonos speaker to group it with a room that's already playing. If different music is playing in different rooms, press and hold **>||** until you hear the sound you want.

Skip to next or previous song

When streaming songs from playlists or your music library, swipe **>||** **::** to change songs.



Swipe right for next track



Swipe left for previous track

Note: This doesn't work with radio stations.

Expand your home theater

You can add a Sub and surrounds to expand your home theater experience. Add them during setup, or anytime later by selecting **...** **> Speakers**. The app guides you through setup.

- Add a Sub for room-filling bass.
- Add a pair of Sonos speakers as rear surrounds.
- Add both a Sub and pair of surrounds for full 5.1 home theater sound.

Placement guidelines

- **Sub**—place it either standing up or lying down; you can place it in a corner, against a wall, behind, under or next to any furniture on any floor surface.
- **Surround speakers**—place the speakers to the left and right of your main viewing position. They can be level with or behind the main viewing position. Make sure both have the same orientation (horizontal or vertical).

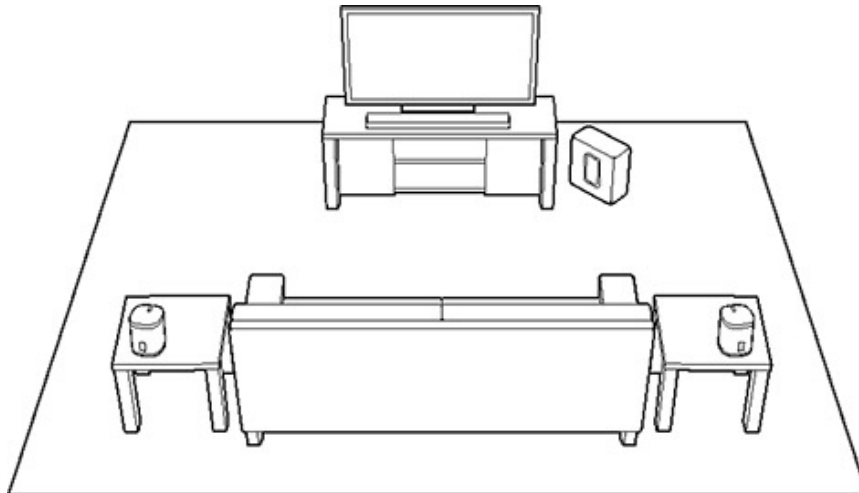

Sub

Add a Sub

You can pair a Sub with any Sonos speaker or amplified component.

On a mobile device:

1. Tap **⋮** > **Settings** > **Room Settings**.
2. Choose the room with the speaker you want to pair, and tap **Add Sub**.

On a computer:

1. Select **Manage** > **Settings** (PC) or **Sonos** > **Preferences** (Mac).
2. Select **Room Settings**.
3. Choose the room with the speaker you want to pair from the *Room Settings* drop down list.
4. From the **Basic** tab, select **Add Sub**.

Change Sub settings

On a mobile device:

1. Tap **⋮** > **Settings** > **Room Settings**.
2. Select the room with the Sub. It appears as *Room (+Sub)*.
3. Select **Advanced Audio** > **Sub Settings** and change a setting.

Sub	Turn the Sub's sound On or Off .
Sub Level	Adjust the Sub's volume. (You can use this setting to match the subwoofer level to the level of your main speakers.)
Placement Adjustment (phase)	Turn On or Off .

On a computer:

1. Select **Manage** > **Settings** (PC) or **Sonos** > **Preferences** (Mac).
2. Select **Room Settings**.
3. Choose the room with the Sub from the *Room Settings* drop down list. It appears as *Room (+Sub)*.
4. Select the **Sub** tab and change a setting.

Sub	Turn the Sub's sound On or Off .
Sub Level	Adjust the Sub's volume. (You can use this setting to match the subwoofer level to the level of your main speakers.)
Placement Adjustment (phase)	Turn On or Off .

Remove a Sub

On a mobile device:

1. Tap **...** > **Settings** > **Room Settings**.
2. Select the room with the Sub. It appears as *Room (+Sub)*.
3. Select **Remove Sub**.
4. Choose one of the following:
 - To pair the Sub with a different speaker, select **Choose Room for Sub**.
 - If you're not using it, select **Don't use Sub**. It appears in Rooms as *Sub (unused)* until you pair it with a speaker.

On a computer:

1. Select **Manage** > **Settings** (PC) or **Sonos** > **Preferences** (Mac).
2. Select **Room Settings**.
3. Choose the room with the Sub from the *Room Settings* drop-down list.
4. From the **Basic** tab, click **Remove Sub**.
5. Choose one of the following:
 - To pair the Sub with a different speaker, select **Choose Room for Sub**.
 - If you're not using it, select **Don't use Sub**. It appears in Rooms as *Sub (unused)* until paired with a speaker.

Surround speakers

Turn two Sonos speakers (same model) into separate right and left channels for your home theater.

Note: If you create a room group or stereo pair instead, you won't have surround sound.

Add surrounds

On a mobile device:

1. Tap **...** > **Settings** > **Room Settings**.
2. Choose the room with the home theater speaker and tap **Add Surrounds**.

On a computer:

1. Select **Manage** > **Settings** (PC) or **Sonos** > **Preferences** (Mac).
2. Select **Room Settings**.
3. Choose the room with the home theater speaker from the *Room Settings* drop-down list.
4. From the **Basic** tab, select **Add Surround Speakers**.

Change surround settings

When you add your speakers as surrounds, surround sound is optimized for your room. You can adjust these settings:

Surrounds	Turn surround sound On or Off .
TV Level	Adjust surround volume for TV audio.
Music Level	Adjust surround volume for music.
Music Playback	Ambient (subtle) or Full (louder, full range). Doesn't apply to TV audio.
Balance Surround Speakers (iOS)	Manually balance your surround speakers.

On a mobile device:

1. Tap **⋮** > **Settings** > **Room Settings**.
2. Choose the room with the surround speakers (name includes (+LS+RS)).
3. Select **Advanced Audio** > **Surround Settings** and change the settings.

On a computer:

1. Select **Manage** > **Settings** (PC) or **Sonos** > **Preferences** (Mac).
2. Select **Room Settings**.
3. Choose the room with the surrounds from the *Room Settings* drop-down list.
4. Select the **Surrounds** tab and change the settings.

Remove surrounds

If the speakers were part of your Sonos system before you added them as surrounds, they'll revert back to their previous room names. Otherwise, they'll appear as **Unused** in **Rooms**.

On a mobile device:

1. Tap **⋮** > **Settings** > **Room Settings**.
2. Choose the room with the surround speakers (name includes (+LS+RS)) and tap **Remove Surrounds**.

On a computer:

1. Select **Manage** > **Settings** (PC) or **Sonos** > **Preferences** (Mac).
2. Select **Room Settings**.
3. Choose the room with the surrounds from the *Room Settings* drop-down list (name includes (+LS+RS)).
4. From the **Basic** tab, click **Remove Surrounds**.

Turn the speaker on or off

Your Sonos speakers are designed to stay on; they use minimal electricity when not in use.

- To stop the music in one room, touch  on the speaker (or use the app).
- To stop the music everywhere, tap  > **Pause All** in the app.

Troubleshooting

Warning: Do not open the product as there is a risk of electric shock. Under no circumstances should the product be repaired by anyone other than an authorized Sonos repair center, as this will invalidate the warranty. Please contact Sonos Customer Support for more information.

Customer Support

- Visit our website at www.sonos.com/support
- Email us at support@sonos.com

Speaker not detected during setup

- Make sure your system is updated to the current software.
- Insert the power cord fully into the home theater speaker and your power source.
- Move speaker closer to your router.

Can't turn off TV's speakers

If you're using the optical adapter, during setup you'll turn off your TV's speakers. Refer to your TV owner's guide for more information.

If you can't turn them off,

1. Use the TV's volume buttons to turn the volume completely down. Do not use the **Mute** button.
2. Use only the volume buttons on your Sonos app to adjust the volume.

Turn off volume control messages

Some TVs may show volume control messages when you adjust the volume, even after you turn off your TV speakers. (If you have Beam, this happens if it's connected to your TV using the optical adapter.)

You may be able to program your remote control to turn off these messages.

1. Program a device key.
 - Refer to your remote control's instructions or the cable box's on-screen help.
 - Contact your cable service provider for more help.
2. In the code list, search for the Sonos code.
 - If Sonos doesn't appear, select a code *other than that of your TV and its connected devices*.
 - *DO NOT initiate an automated search for a code.*
3. Lock the volume control to your home theater speaker.

Note: This feature is sometimes referred to as volume lock or volume punch.

4. Program your remote control to work with your home theater speaker.

Universal remote controls

If you can't program your universal remote control, or want to turn off volume control messages when you adjust the volume, you may want to try switching to Logitech® Harmony® universal remote.

Logitech universal remote controls

You'll need to add your home theater speaker as a device.

1. Use the USB cable provided by Logitech to connect your Harmony remote to your computer.
2. Set up a Logitech user account and install the Harmony Remote software.
3. Launch the Logitech Harmony Remote software or go to www.logitech.com/myharmony and login to your account.
4. Select **Add Device**.
5. Choose an option:
 - Logitech Harmony Remote software
 - My Harmony website
6. Select or enter Sonos as the manufacturer and your home theater speaker as the model name/number.

Note: You may need to add your home theater speaker if it doesn't exist in the database.

Your home network

Your Sonos speakers and the mobile device with the Sonos app need to be on the same Wi-Fi network.

Wireless network

Setting up Sonos on your home Wi-Fi is the answer for most homes. You just need:

- High-speed internet connection such as DSL/cable modem or fiber-to-the-home broadband connection
- High-speed DSL/cable modem (or fiber-to-the-home broadband connection)
- 2.4GHz 802.11b/g/n wireless home network

Note: Satellite internet access may cause playback issues.

Wired home network

Connect a Sonos Boost or speaker to your router with an Ethernet cable if:

- Your Wi-Fi is slow, temperamental, or doesn't reach all the rooms where you want to use Sonos.
- Your network is already in high demand with streaming video and internet usage and you want a separate wireless network just for your Sonos system.
- Your network is 5GHz only (not switchable to 2.4GHz).
- Your router supports only 802.11n (you can't change the settings to support 802.11b/g/n).

Note: For uninterrupted playback, use an Ethernet cable to connect the computer or NAS drive that has your music library files to your router.

Got a new router?

If you purchase a new router or change your internet service provider (ISP), you'll need to restart your Sonos products after the router is installed.

Note: If you keep a Sonos product connected to your router and an ISP technician connects it to the new router, then you'll only need to restart your other Sonos products.

1. After the router is set up, disconnect the power cords from your Sonos products for at least 5 seconds.
2. Reconnect all the power cords—if you keep a Sonos product connected to your router, start with that one. The speaker status light turns solid white on each product when the restart is complete. If you don't have a Sonos product connected to your router, you'll need to change your network password in the Sonos app.

Change your network password

If you change your network password (and you don't have a Sonos product connected to your router), you'll need to update the password in the Sonos app.

1. Connect a Sonos speaker to your router with an Ethernet cable.
2. Choose an option:
 - On a mobile device, go to **⋮ > Settings > Advanced Settings > Wireless Setup**.
 - On a PC, go to **Manage > Settings > Advanced**. On the **General** tab, select **Wireless Setup**.
 - On a Mac, go to **Sonos > Preferences > Advanced**. On the **General** tab, select **Wireless Setup**.
3. Enter the new network password.

Once the password is accepted you can unplug the speaker from the router and move it back to its original location.

Important safety information

Please read these instructions and heed all warnings. Keep them in a convenient location and make sure everyone in the household is aware of them.

Location

- Do not place the unit where it will be exposed to excessive heat (e.g., radiators, heat registers, stoves), direct sunlight, or a dusty environment (e.g., woodworking shop.)
- Do not place the unit where it will be exposed to flammable liquids and/or fumes.
- Allow at least 1" between the unit and any walls or surfaces.
- Protect the power cable from being walked on or pinched, particularly at plugs, convenience receptacles, and the point where it exits the product. The mains cord should be readily available to disconnect the power.
- The product should not be used near water—avoid close proximity to a bathtub, kitchen sink, laundry tub, wet basement, swimming pool, etc.

- The home theater speaker is for indoor use only. Do not expose to rain or snow.

Proper Ventilation

- Leave one inch of open space around the sides and above the unit to ensure proper ventilation.
- Ventilation should not be impeded by covering the ventilation openings with items such as tablecloths, curtains, or papers.
- Do not let foreign objects into the unit. If a foreign object should get into the unit, unplug the unit and contact Sonos for servicing guidance.

Warning

- Do not operate or handle the product with wet hands.
- Only use attachment/accessories specified by Sonos.
- Unplug the power cord during lightning storms or when unused for long periods of time.
- Never disassemble or modify the product in any way.

Cleaning & maintenance

- Dust with a dry, soft cloth. A cloth moistened with water or gentle household cleaner may be used to clean dirt or stains, but unplug the product first. Do not spray liquids directly onto the product.
- Do not use chemical solvents (e.g. alcohol, benzene, paint thinner) or other flammable cleaning liquids.
- Refer all servicing to Sonos qualified service personnel. Servicing is required when the unit or the power cord has been damaged in any way, if liquid or other foreign matter has fallen into the ventilation openings, or the unit has been exposed to rain or moisture.



Warning: To reduce the risk of fire or electric shock, do not expose this apparatus to rain or moisture.

Specifications

Feature	Description
Audio	
Amplifier	Five Class-D digital amplifiers.
Elliptical Woofer	Four full-range woofers ensures you'll hear the faithful playback of mid-range vocal frequencies plus deep, rich bass.
Tweeter	One tweeter creates a crisp and clear high-frequency response.
3.0 Home Theater	<ul style="list-style-type: none"> • Five-speaker design plunges you into the cinematic action with huge waves of sound that capture every whisper and footfall. • Connects to your TV with a single cable and plays all sources, including satellite boxes and game consoles.

Feature	Description
Microphones	<ul style="list-style-type: none"> • Five far-field microphone array uses for advanced beam forming and multichannel echo cancellation. • LED hard-wired to voice microphones for privacy control so you know when the microphone is active.
Voice Control	Integrated voice control.
System Requirements	TV with HDMI ARC or optical digital audio output, broadband internet, and the Sonos app.
Music	
Music Services	Sonos works seamlessly with most music services, including Apple Music™, Google Play Music, Pandora, Spotify and Radio by TuneIn, as well as downloads from services offering DRM-free tracks. Availability varies by region. See http://www.sonos.com/streaming-music .
Internet Radio	Streaming MP3, HLS/AAC, WMA
Audio Formats	<ul style="list-style-type: none"> • TV support: Dolby Digital and PCM. • Music support: compressed MP3, AAC (without DRM), WMA without DRM (including purchased Windows Media downloads), AAC (MPEG4), AAC+, Ogg Vorbis, Apple Lossless, Flac (lossless) music files, as well as uncompressed WAV and AIFF files. • Native support: 44.1kHz sample rates. Additional support for 48kHz, 32kHz, 24kHz, 22kHz, 16kHz, 11kHz, and 8kHz sample rates. MP3 supports all rates except 11kHz and 8kHz. <p>Note: Apple “FairPlay”, WMA DRM and WMA Lossless formats not supported. Previously purchased Apple “FairPlay” DRM-protected songs may be upgraded.</p>
Album Art	JPEG, PNG, BMP, GIF
Playback Modes	Crossfade, shuffle, repeat
Playlists	iTunes, Napster, WinAmp, and Windows Media Player (.m3u, .pls, .wpl)
Networking	
Ethernet Port	One 10/100 Mbps Ethernet port.
Wireless Connectivity	See <u>Your home network</u> .
SonosNet™ Extender	Extends the power of SonosNet, a secure AES encrypted, peer-to-peer wireless mesh network dedicated for your Sonos system to reduce Wi-Fi interference.
General	
Touch Controls	Volume +/-, Play/Pause, Next/Previous Track, Microphone
Top Panel LEDs	Status and microphone indicators
Input Power	100 – 240 VAC, 50/60 Hz, 2.5 A (Refer to bottom of the enclosure)

Feature	Description
Dimensions (H x W x D)	2.68" H x 25.63" W x 3.94" D (68mm x 651mm x 100mm)
Weight	6.2 lbs. (2.8 kg)
Operating Temperature	32°F to 104°F (0°C to 40°C)
Storage Temperature	-4°F to 122°F (-20°C to 50°C)
Package Contents	Soundbar, AC power cord, HDMI cable, optical adapter, quickstart guide, warranty and regulatory booklet.
Control	Use your remote control, voice, touch controls or the Sonos app
Supported Devices	Works with amplified and non-amplified Sonos products. Connects to TV with HDMI cable (with or without an attached optical adapter). Plays sources connected to the TV, including cable boxes and game consoles.

* Specifications subject to change without notice.

Product guide feedback?

We'd love to hear from you! We'll read your feedback carefully and use it to help us improve our product guides. Write to us at: docfeedback@sonos.com

If you're having a problem with your Sonos system, please contact Customer Care so they can help. Email them at <http://www.sonos.com/emailsupport>.

Need more help?

- Tap **...** > **Help & Tips** to get some simple tips for getting the most out of your speakers.
- Visit our Frequently Asked Questions (FAQ) pages at www.sonos.com/support.
- Ask us a question at <http://www.sonos.com/emailsupport>.