

SONY®

Sound Bar

Operating Instructions



HT-XF9000

WARNING

Do not install the appliance in a confined space, such as a bookcase or built-in cabinet.

To reduce the risk of fire, do not cover the ventilation opening of the appliance with newspapers, tablecloths, curtains, etc. Do not expose the appliance to naked flame sources (for example, lighted candles).

To reduce the risk of fire or electric shock, do not expose this appliance to dripping or splashing, and do not place objects filled with liquids, such as vases, on the appliance.

The unit is not disconnected from the mains as long as it is connected to the AC outlet, even if the unit itself has been turned off.

As the main plug is used to disconnect the unit from the mains, connect the unit to an easily accessible AC outlet. Should you notice an abnormality in the unit, disconnect the main plug from the AC outlet immediately.

CAUTION

Risk of explosion if the battery is replaced by an incorrect type. Do not expose batteries or appliances with battery-installed to excessive heat, such as sunshine and fire.

Indoor use only.

Recommended cables

Properly shielded and grounded cables and connectors must be used for connection to host computers and/or peripherals.

For the Bar Speaker

The nameplate is located on the bottom of the Bar Speaker.

For the customers in Europe

Notice for customers: the following information is only applicable to equipment sold in countries applying EU directives.

This product has been manufactured by or on behalf of Sony Corporation. EU Importer: Sony Europe Limited. Inquiries to the EU Importer or related to product compliance in Europe should be sent to the manufacturer's authorized representative, Sony Belgium, *bijkantoor van Sony Europe Limited, Da Vincilaan 7-D1, 1935 Zaventem, Belgium.*



Hereby, Sony Corporation declares that this equipment is in compliance with Directive 2014/53/EU.

The full text of the EU declaration of conformity is available at the following internet address:
<http://www.compliance.sony.de/>

This equipment has been tested and found to comply with the limits set out in the EMC regulation using a connection cable shorter than 3 meters.

This radio equipment is intended to be used with the approved version(s) of software that are indicated in the EU Declaration of Conformity. The software loaded on this radio equipment is verified to comply with the essential requirements of the Directive 2014/53/EU.

The software version can be found via: Refer to [Software Version] under  [Setup] - [Advanced Settings] - [System Settings].



**Disposal of waste
batteries and
electrical and
electronic
equipment
(applicable in the
European Union**

**and other countries with separate
collection systems))**

This symbol on the product, the battery or on the packaging indicates that the product and the battery shall not be treated as household waste. On certain batteries this symbol might be used in combination with a chemical symbol. The chemical symbol for lead (Pb) is added if the battery contains more than 0.004% lead. By ensuring that these products and batteries are disposed of correctly, you will help to prevent potentially negative consequences for the environment and human health which could be caused by inappropriate waste handling. The recycling of the materials will help to conserve natural resources. In case of products that for safety, performance or data integrity reasons require a permanent connection with an incorporated battery, this battery should be replaced by qualified service staff only. To ensure that the battery and the electrical and electronic equipment will be treated properly, hand over these products at end-of-life to the appropriate collection point for the recycling of electrical and electronic equipment. For all other batteries, please view the section on how to remove the battery from the product safely. Hand the battery over to the appropriate collection point for the recycling of waste batteries. For more detailed information about recycling of this product or battery, please contact your local Civic Office, your household waste disposal service or the shop where you purchased the product or battery.

Table of Contents

What's in the Box	6
What You Can Do with the System	7
Guide to Parts and Controls	8
About the Home Menu	13

Connecting to a TV or AV Device

Connecting to a TV or AV Device with the HDMI Cable	➔	Startup Guide (separate document)
---	---	-----------------------------------

Connecting Sony TV with the BLUETOOTH Function Wirelessly	15
Connecting a TV with an Analog Audio Cable	18
Connecting a 4K TV and 4K Devices	19
Connecting a TV Compatible with eARC	21

Preparing to Use the System

Mounting the Bar Speaker on a Wall	23
Performing the Wireless Connection of the Subwoofer (SECURE LINK)	25
When the TV Remote Control does not Work	26

Watching Images

Watching TV	27
Playing the Connected AV Device	27

Listening to Music/Sound

Listening to Music/Sound with the BLUETOOTH® Function	28
Listening to Music on a USB Device	30

Listening to the Device Connected with an Analog Audio Cable	31
--	----

Adjusting the Sound Quality

Enjoying Immersive Surround Experience (VERTICAL S.)	32
Setting the Sound Effect that is Tailored to Sound Sources (Sound Mode)	33
Making Dialogs Clearer (VOICE)	34
Enjoying Clear Sound with Low Volume at Midnight (NIGHT)	34
Adjusting the Volume of the Subwoofer	35
Adjusting the Delay Between the Picture and Sound	35
Playing Compressed Audio Files or CDs in Natural Sound Quality (DSEE)	37
Enjoying Multiplex Broadcast Sound (AUDIO)	37
Adjusting the Dialog Volume While the DTS:X Content is Played Back	38

Using the Control for HDMI Function

Using the Control for HDMI Function	40
Using the "BRAVIA" Sync Function	42

Changing the Settings

Customizing the Speaker Settings for Surround Sound	43
Changing the Brightness of the Indicators (DIMMER)	44
Saving Power in Standby Mode	44

Performing Easy Setup	45
Performing Advanced Settings	46
Updating the Software	50
Troubleshooting	
Troubleshooting	51
Resetting the System	57
Additional Information	
Specifications	58
Radio Frequency Bands and Maximum Output Power	60
Playable Types of Audio Files	61
Supported Input Audio Formats	62
Supported HDMI Video Formats	63
On BLUETOOTH Communication	65
END USER LICENSE AGREEMENT	66
Precautions	70
Index	73

What's in the Box

- Bar Speaker (1)

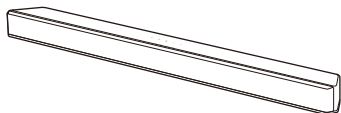

- Subwoofer (1)



- Remote control (1)

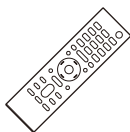

- R03 (size AAA) battery (2)



- Optical digital cable (1)

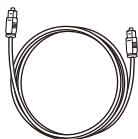

- WALL MOUNT TEMPLATE (1)



- Startup Guide



- Operating Instructions

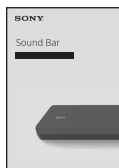

What You Can Do with the System

The system supports object-based audio formats such as Dolby Atmos and DTS:X as well as HDR video formats such as HDR10, HLG, and Dolby Vision.

"Watching TV" (page 27)
"Playing the Connected AV Device" (page 27)

Blu-ray Disc™ player, cable box, satellite box, etc.

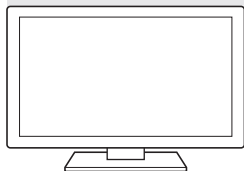
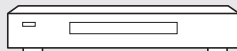

"Connecting Sony TV with the BLUETOOTH Function Wirelessly" (page 15)

Basic connection: Refer to "Startup Guide" (separate document).
Other connections: See "Connecting to a TV or AV Device" (page 15).

"Using the Control for HDMI Function" (page 40)
"Using the "BRAVIA" Sync Function" (page 42)

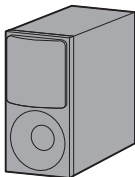
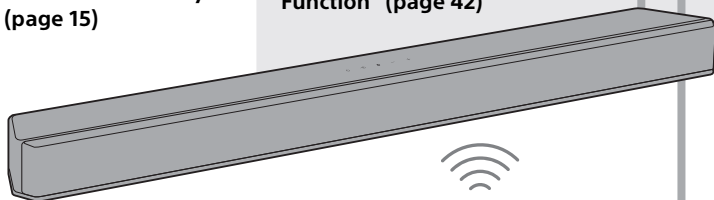

"Performing the Wireless Connection of the Subwoofer (SECURE LINK)" (page 25)

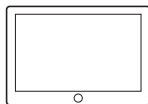

"Listening to Music/Sound with the BLUETOOTH® Function" (page 28)



"Listening to Music on a USB Device" (page 30)

Guide to Parts and Controls

Details are omitted from the illustrations.

Bar Speaker (Main Unit)

Front

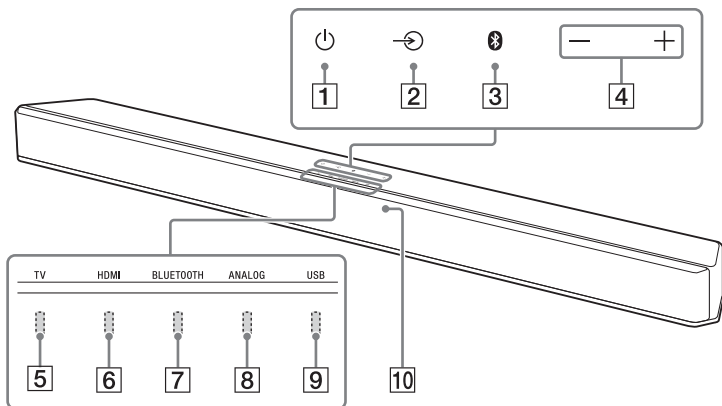

1 **⏻ (power) button**

Turns on the system or sets it to standby mode.

2 **↻ (input select) button**

Selects the input for playback on the system.

3 **BLUETOOTH button (page 28)**

4 **+/- (volume) buttons**

5 **TV indicator**

Lights when the TV input is selected (page 27).

6 **HDMI indicator**

Lights when the HDMI input is selected (page 27).

7 **BLUETOOTH indicator**

– Flashes quickly in blue: During pairing standby status

- Flashes in blue: BLUETOOTH connection is being attempted.
- Flashes slowly in blue: The BLUETOOTH function is turned off. To use the BLUETOOTH function, set [Bluetooth Mode] to [Receiver].
- Lights in blue: BLUETOOTH connection has been established.

8 **ANALOG indicator**

Lights when the ANALOG input is selected (page 31).

9 **USB indicator**

Lights when the USB input is selected (page 30).

10 **Remote control sensor**

Point the remote control at the remote control sensor to operate the system.

Rear

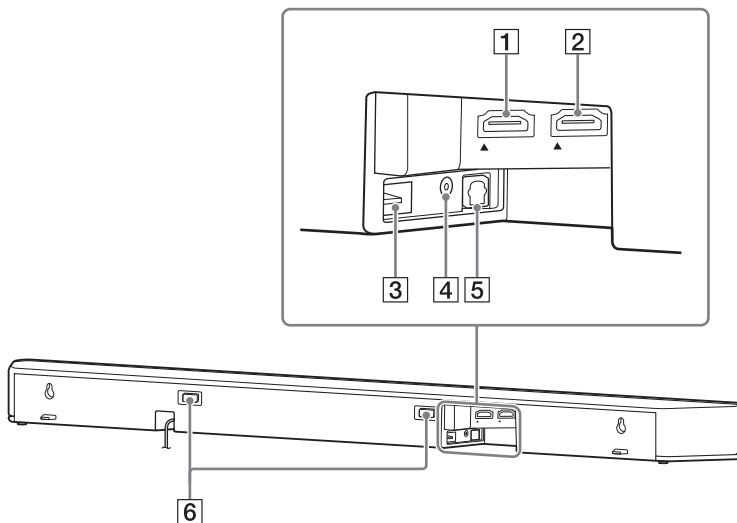

1 HDMI IN jack

For specifications and notes on connections, see “Supported HDMI Video Formats” (page 63).

2 HDMI OUT (TV eARC/ARC) jack

Connect a TV that has an HDMI input jack with an HDMI cable. The system is compatible with eARC and ARC. ARC is the function that sends TV sound to an AV device such as the system from the TV’s HDMI jack. eARC is an extension of ARC and enables transmission of the object audio and multi-channel LPCM content that cannot be transmitted with ARC. For details of eARC, see “Connecting a TV Compatible with eARC” (page 21). For supported audio formats, see “Supported Input Audio Formats” (page 62). For specifications and

notes on connections, see “Supported HDMI Video Formats” (page 63).

3 (USB) port (page 30)

4 ANALOG IN jack

5 TV IN (OPT) jack

6 IR repeater (page 26)

Transmits the remote signal of the TV remote control to the TV.

Subwoofer

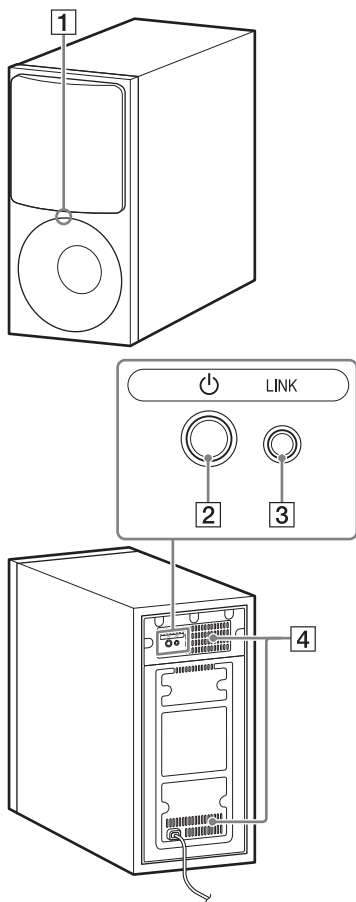

1 Power indicator

- Lights in red: The subwoofer is in standby mode.
- Lights in green: The subwoofer is connected to the system.
- Lights in amber: The subwoofer is connected to the system with the Secure Link function.
- Flashes in green: The subwoofer is attempting to connect to the system.
- Flashes in amber: The subwoofer is attempting to connect to the system with the Secure Link function.
- Turns off: The subwoofer is turned off.

2 (power) button

Turns on or off the subwoofer.

3 LINK button (page 25)

4 Ventilation holes

For safety, do not block the ventilation holes.

Remote Control

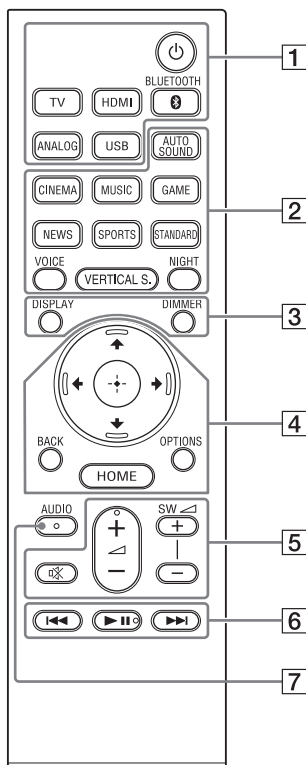

- 1** (power)
Turns on the system or sets it to standby mode.
TV (page 27)
HDMI (page 27)
BLUETOOTH (page 29)
ANALOG (page 31)
USB (page 30)
- 2** **AUTO SOUND (page 33)**
CINEMA (page 33)
MUSIC (page 33)
GAME (page 33)
NEWS (page 33)
SPORTS (page 33)
STANDARD (page 33)
VOICE (page 34)
VERTICAL S. (page 32)
NIGHT (page 34)
- 3** **DISPLAY**
Displays playback information on the TV screen.
Playback information is not displayed for the TV input.
DIMMER (page 44)
- 4** (page 13)
+ (enter) (page 13)
BACK (page 13)
OPTIONS (page 35)
Displays the options menu on the TV screen.
The options menu is not displayed for the TV input.
HOME (page 13)

5 (muting)

Turns off the sound temporarily.

 (volume) +*/-

Adjusts the volume.

SW  (subwoofer volume) +/-

Adjusts the volume of the subwoofer.

6 Playback operation buttons

 (previous/next)



Selects the previous/next track or file.

Pressing and holding searches backward or forward (rewind/fast forward) during playback.

 (play/pause)*

Starts, pauses, or re-starts playback (resume play).

7 AUDIO* (page 37)

* The AUDIO, , and  + buttons have a tactile dot. Use it as a guide during operation.

About the replacement of batteries for the remote control

When the system does not respond by operating with the remote control, replace two batteries with new batteries.

Use R03 (size AAA) manganese batteries for replacement.

About the Home Menu

You can display the home menu on the TV screen by connecting the system and TV with the HDMI cable (not supplied). From the home menu, you can set the various settings and select the input.

The home menu is displayed in the language that is selected in [Easy Setup]. (The following screen is an example when English is selected.)

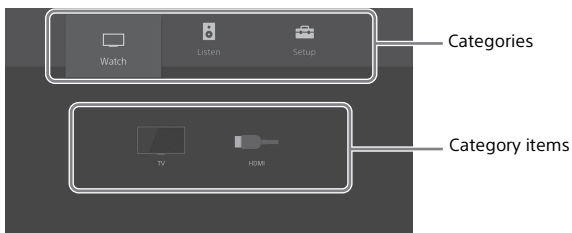

Using the Home Menu

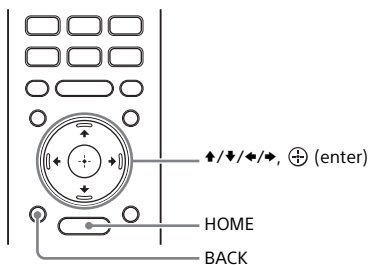

- 1 Press HOME.**
The home menu appears on the TV screen.
- 2 Press ↑/↓/←/→ to select the category that you want, then press ↓ or ⊕.**
The items for the selected category appear under the category list on the TV screen.
- 3 Press ↑/↓/←/→ to select the item that you want, then press ⊕.**
The selected input or setting display appears on the TV screen.
To return to the previous screen, press BACK.

[Watch]

Selects the input of the TV or AV device that is connected to the system.
See "Watching Images" (page 27).

[Listen]

Selects the input of the audio device that is connected to the system.
See "Listening to Music/Sound" (page 28).





[Setup]

Performs the basic initial settings by using [Easy Setup] or various advanced settings of the system.





See "Performing Easy Setup" (page 45) or "Performing Advanced Settings" (page 46).

About the Steps Description





In these Operating Instructions, the operations are described as steps that are operated on the home menu displayed on the TV screen by using the remote control while the system and TV are connected with the HDMI cable (not supplied).

The operating steps that select items on the TV screen by using /// and  are simplified in the following way.

Example: Select  [Setup] - [Advanced Settings] on the home menu.

The operation that selects a category and category item by pressing /// and  is expressed as "select." The category and category item are linked with "-."

Example: Select [Speaker Settings] - [Manual Speaker Settings].

When repeating the operation that selects an item by pressing /// and , the selected items are linked with "-."

Tips

- You can use the buttons on the main unit if they have the same or similar names as those on the remote control.
- Characters in brackets [] appear on the TV screen.

Connecting to a TV or AV Device with the HDMI Cable

To connect a 4K TV or 4K devices

See "Connecting a 4K TV and 4K Devices" (page 19).

To connect a TV compatible with eARC

For the connection, refer to Startup Guide (separate document). For the settings, see "Connecting a TV Compatible with eARC" (page 21).

To connect to a TV other than the above, refer to Startup Guide (separate document).

Connecting Sony TV with the BLUETOOTH Function Wirelessly

When using Sony TV* with the BLUETOOTH function, you can listen to sound of the TV or device that is connected to the TV by connecting the system and TV wirelessly.

* The TV needs to be compatible with A2DP (Advanced Audio Distribution Profile) of the BLUETOOTH profile.

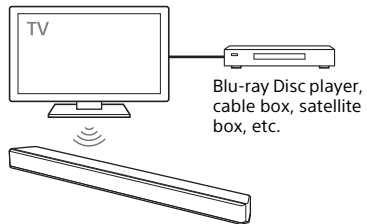

Notes

- If connecting the system and TV by using the BLUETOOTH function, you cannot display the operation screen for the system such as the home menu on the TV screen, and use the function of the system other than the listening function for the sound of the TV or device that is connected to the TV.
To use all the functions of the system, connect the system and TV with the HDMI cable (not supplied). For details about connections and operations to listen to TV sound by connecting with the HDMI cable, refer to Startup Guide (separate document).
- This function is available only for Sony TV that is compatible with BLUETOOTH A2DP.

Listening to TV Sound by Connecting the System and TV Wirelessly

To connect the system and TV wirelessly, you need to perform pairing of the system and TV by using the BLUETOOTH function.

Pairing is the process required to mutually register the information on BLUETOOTH devices to be connected wirelessly in advance.

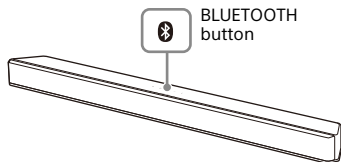
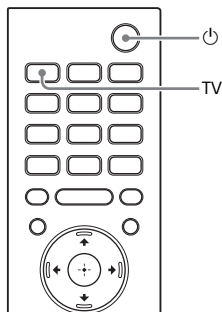

- 1 Set up the remote control.**
- 2 Turn on the TV.**
- 3 Turn on the system.**
- 4 Press and hold the BLUETOOTH button on the main unit and TV on the remote control simultaneously for 5 seconds.**

The system enters the pairing mode and the BLUETOOTH indicator flashes quickly.

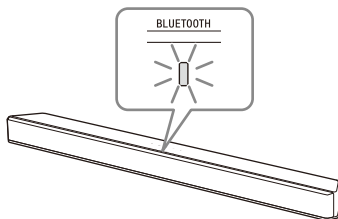

- 5 On the TV, search the system by performing the pairing operation.**

The list of the BLUETOOTH devices that are searched appears on the TV screen.

For the operation method to pair the BLUETOOTH device to the TV, refer to the operating instructions of the TV.

- 6 Pair the system and TV by selecting "HT-XF9000" from the list on the TV screen.**

- 7 Make sure that the BLUETOOTH and TV indicators on the main unit light.**

A connection between the system and TV has been established.

- 8 Select the program or input of the device by using the TV remote control.**

The sound of the displayed image on the TV screen is output from the system.

- 9 Adjust the volume of the system by using the TV remote control.**

When pressing the muting button on the TV remote control, the sound is muted temporarily.

Notes

- If the TV sound is not output from the system, press TV and check the status of the indicators on the Bar Speaker.

- The BLUETOOTH and TV indicators light: The system and TV are connected and TV sound is output from the system.
 - The BLUETOOTH indicator flashes quickly: Perform pairing on the TV.
 - The TV indicator lights: Perform steps from the start.
- When you connect the system and TV with the HDMI cable (not supplied), the BLUETOOTH connection is canceled. To connect the system and TV with the BLUETOOTH function again, disconnect the HDMI cable, then perform the connecting operation from the start.

Listening to Sound of the Paired TV

You can turn the system on/off, adjust the volume, and mute the sound by using the TV remote control when connecting the TV to the system wirelessly.

1 Turn the TV on with the TV remote control.

The system is turned on by interlocking with the TV power, and TV sound is output from the system.

2 Select the program or input of the device by using the TV remote control.

The sound of the displayed image on the TV screen is output from the system.

3 Adjust the volume of the system by using the TV remote control.

When pressing the muting button on the TV remote control, the sound is muted temporarily.

Tip

When the TV is turned off, the system is also turned off by interlocking with the TV power.

About operations with the remote control that is supplied with the system

You can use the following buttons. You can adjust the volume of the subwoofer, and adjust sound quality in addition to turning the system on/off and adjusting volume that can be operated by the TV remote control.

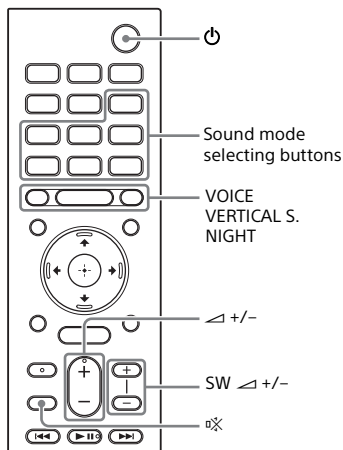

Notes

- If you select the input other than TV on the remote control supplied with the system, the TV sound is not output from the system. To output the TV sound, press TV on the remote control to change to the TV input.
- During the connecting the TV with the BLUETOOTH function, the following remote control buttons do not work. **↕/↔/↔/↕**, **⊕** (enter), **OPTION**, **HOME**, **DISPLAY**, **▶||** (play/pause), **◀◀/▶▶** (previous/next)

Connecting a TV with an Analog Audio Cable

To connect the following devices to the system, connect them via the ANALOG IN jack on the system.

- TVs that do not have an HDMI jack and optical digital output jack
- Portable audio devices such as smartphones and WALKMAN®

For listening to the connected device, see "Listening to the Device Connected with an Analog Audio Cable" (page 31).

Note

If the TV's headphone jack also serves as an audio output jack, check the audio output settings of the TV. For details, refer to the operating instructions of the TV.

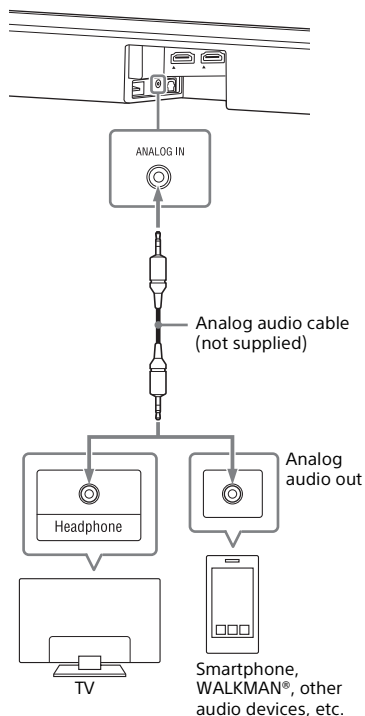

Connecting a 4K TV and 4K Devices

All HDMI jacks on the system support 4K video format and HDCP2.2 (High-bandwidth Digital Content Protection System Revision 2.2).

To watch 4K video content, connect the 4K TV and 4K devices to the system via an HDCP2.2-compatible HDMI jack on each device.

You can only view 4K video content through the HDCP2.2-compatible HDMI jack connection.

When an HDCP2.2-Compatible HDMI Jack on the TV is Labeled with "eARC" or "ARC"

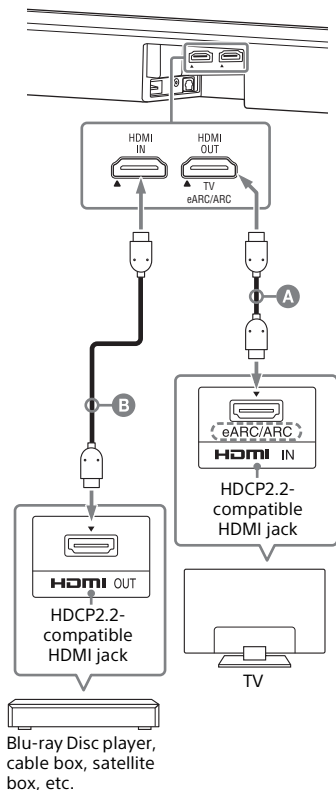

A HDMI cable (not supplied)

B HDMI cable (not supplied)

Use an HDMI cable which supports the 4K video format that you want to watch. For details, see "Supported HDMI Video Formats" (page 63).

- 1 Check which HDMI IN jack on your TV is compatible with HDCP2.2.**
Refer to the operating instructions of the TV.
- 2 Connect the HDCP2.2-compatible HDMI IN jack on the TV and HDMI OUT jack on the main unit with the HDMI cable (not supplied).**
TV connection is complete.
- 3 Connect the HDCP2.2-compatible HDMI OUT jack of the 4K device and HDMI IN jack of the main unit with the HDMI cable (not supplied).**
Refer to the operating instructions of the 4K device to check that the HDMI OUT jack of the 4K device is compatible with HDCP2.2.
4K device connection is complete.

When an HDCP2.2-Compatible HDMI Jack on the TV is not Labeled with "eARC" or "ARC"

If your TV's HDCP2.2-compatible HDMI IN jack is not compatible with eARC or ARC, the TV sound is not output from the system.
In this case, connect the optical output jack of the TV and the TV IN (OPT) jack on the main unit with the optical digital cable (supplied).

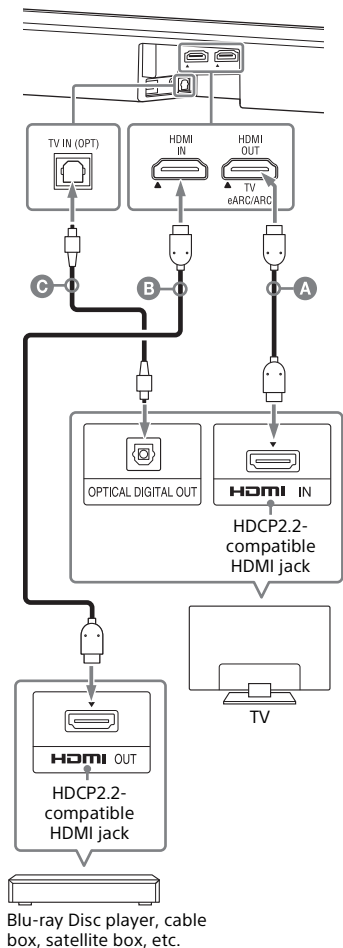

- A HDMI cable (not supplied)**
- B HDMI cable (not supplied)**
Use an HDMI cable which supports the 4K video format that you want to watch. For details, see "Supported HDMI Video Formats" (page 63).
- C Optical digital cable (supplied)**

Setting the HDMI Signal Format to Watch 4K Video Content

To watch 4K video content, select the appropriate setting for the connected 4K TV and 4K device.

- 1 Press HOME.**
The home menu appears on the TV screen.
- 2 Select  [Setup] - [Advanced Settings] on the home menu.**
- 3 Select [HDMI Settings] - [HDMI Signal Format].**
The [HDMI Signal Format] screen appears on the TV screen.
- 4 Select [HDMI IN], then select the setting you want.**
 - [Standard format] (default setting): Select when the connected TV and devices support standard bandwidth video formats.
 - [Enhanced format]: Select when both the connected TV and devices support high bandwidth video formats such as 4K 60p 4:4:4 etc.

For the relation of the [HDMI Signal Format] setting options, supported video format signals, and HDMI cables to be used, see "Supported HDMI Video Formats" (page 63).

Notes

- Depending on the TV, the TV setting for HDMI output may be required. Refer to the operating instructions of the TV.
- When the picture is not displayed after [HDMI Signal Format] is set to [Enhanced format], set it to [Standard format].

Connecting a TV Compatible with eARC

The system is compatible with eARC (Enhanced Audio Return Channel). eARC is a new function standardized by HDMI 2.1 and supports latest audio formats in addition to audio formats that are supported with existing ARC (Audio Return Channel).

You can enjoy object audio content, such as Dolby Atmos - Dolby TrueHD and DTS:X, or multi-channel LPCM content that cannot be transmitted with ARC by connecting the system and TV compatible with eARC using an HDMI cable.

For the connection, refer to Startup Guide (separate document).

Preparing to Use the eARC Function

- 1 If the HDMI output jack of the system is labeled with "ARC," perform a software update (page 50).**
The system is compatible with the eARC function if the HDMI output jack of the system is labeled with "eARC/ARC."
- 2 Press HOME.**
The home menu appears on the TV screen.
- 3 Select  [Setup] - [Advanced Settings] on the home menu.**

4 Select [HDMI Settings] - [eARC] - [On].

The eARC function is enabled and it works while connecting a TV compatible with eARC.

The ARC function works while connecting a TV compatible with ARC (not compatible with eARC).

Notes

- If [eARC] does not appear on the setup display in step 4, perform a software update (page 50).
- When [eARC] is set to [On], make sure of the eARC setting of the connected TV. For details, refer to the operating instructions of the TV.

Preparing to Use the System

Mounting the Bar Speaker on a Wall

You can mount the Bar Speaker on a wall.

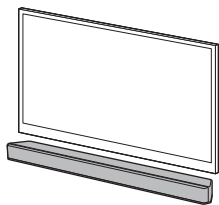

Notes

- Prepare screws (not supplied) that are suitable for the wall material and strength. As a plasterboard wall is especially fragile, attach the screws securely in the wall beam. Install the speakers horizontally, hung by screws in studs in a continuous flat section of the wall.
- Have the installation done by a Sony dealer or licensed contractor and pay special attention to safety during the installation.
- Sony shall not be held responsible for accidents or damage caused by improper installation, insufficient wall strength, improper screw installation or natural disaster, etc.

- 1 Prepare two screws (not supplied) that are suitable for the wall mount holes on the rear of the Bar Speaker.**

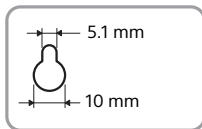
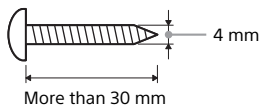

Hole on the rear of the Bar Speaker

- 2 Stick WALL MOUNT TEMPLATE (supplied) on a wall.**

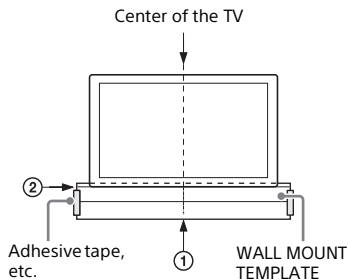

- 1 Align TV CENTER LINE (①) of WALL MOUNT TEMPLATE with the center line of your TV.**
- 2 Align TV BOTTOM LINE (②) of WALL MOUNT TEMPLATE with the bottom of your TV, then stick WALL MOUNT TEMPLATE on a wall by using a commercially available adhesive tape, etc.**

- 3** Fasten the screws into the marks (ⓑ) on SCREW LINE (ⓐ) of WALL MOUNT TEMPLATE as in the illustration below.

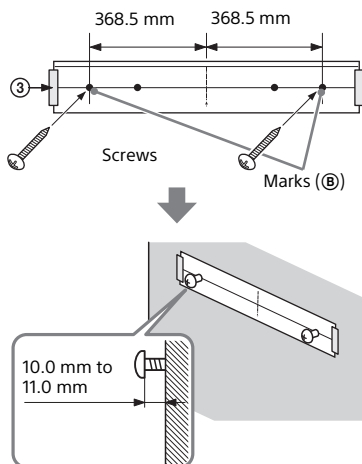

Notes

- When sticking WALL MOUNT TEMPLATE, smooth it out fully.
- When you do not use WALL MOUNT TEMPLATE, install the Bar Speaker apart from the TV by 70 mm or more.

- 4** Remove WALL MOUNT TEMPLATE.

- 5** Hang the Bar Speaker on the screws.

Align the holes of the rear of the Bar Speaker with the screws, then hang the Bar Speaker on the two screws.

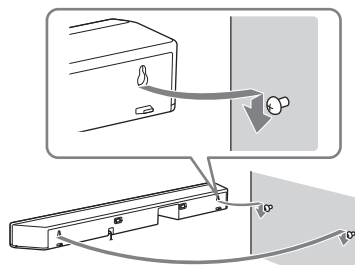

Performing the Wireless Connection of the Subwoofer (SECURE LINK)

You can specify the wireless connection to link the system to the subwoofer using the Secure Link function. We recommend to perform the Secure Link function to prevent interference if you use multiple same products or your neighbors use same products.

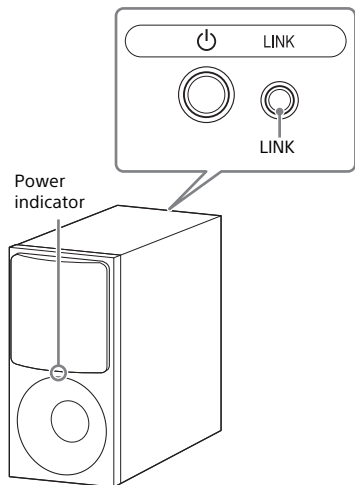

- 1 Press HOME.**
The home menu appears on the TV screen.
- 2 Select  [Setup] - [Advanced Settings] on the home menu.**
- 3 Select [Speaker Settings] - [Secure Link].**

- 4 Select [On].**
The [Secure Link] screen appears on the TV screen.
- 5 Press LINK on the rear of the subwoofer.**
The power indicator of the subwoofer flashes in amber. Proceed to the next step within 2 minutes.
- 6 Select [Start].**
The link setting starts.
To return to the previous display, select [Cancel].
- 7 Complete the link setting by following the on-screen message.**
The power indicator of the subwoofer lights in amber.

Note

If the message [Cannot set Secure Link.] appears, follow the on-screen instructions.

When the TV Remote Control does not Work

When the main unit obstructs the remote control sensor of the TV, the TV remote control may not work. In that case, enable the IR repeater function of the system.

You can control the TV with the TV remote control by sending the remote signal from the rear of the main unit.

1 Press HOME.

The home menu appears on the TV screen.

2 Select [Setup] - [Advanced Settings] on the home menu.

3 Select [System Settings] - [IR-Repeater].

The [IR-Repeater] screen appears on the TV screen.

4 Select [On].



Notes

- Be sure to check that the TV remote control cannot control the TV, and then set [IR-Repeater] to [On]. If it is set to [On] when the remote control can control the TV, appropriate operation may not be obtained because of the interference between the direct command from the remote control and command via the main unit.
- If [IR-Repeater] is set to [On], this function may not work depending on your TV. Also, the remote controls of other devices such as an air conditioner may not work correctly. In this case, change the installation position of the system or TV.

Watching TV

- 1 Press HOME.**

The home menu appears on the TV screen.
- 2 Select  [Watch] - [TV] on the home menu.**
- 3 Select the program using the TV remote control.**

The selected TV program appears on the TV screen and the TV sound is output from the system.
- 4 Adjust the volume.**
 - Adjust the volume by pressing  +/- on the remote control.
 - Adjust the subwoofer volume by pressing SW  +/- on the remote control (page 35).

Note

Set the speaker setting of the TV (BRAVIA) to Audio System. Refer to the operating instructions of your TV regarding how to set the TV.



Tip

You can select [TV] directly by pressing TV on the remote control.

Playing the Connected AV Device

- 1 Press HOME.**

The home menu appears on the TV screen.
- 2 Select  [Watch] - [HDMI] on the home menu.**

The image of the selected device appears on the TV screen and the sound is output from the system.
- 3 Adjust the volume.**
 - Adjust the volume by pressing  +/- on the remote control.
 - Adjust the subwoofer volume by pressing SW  +/- on the remote control (page 35).

Tip

You can select [HDMI] directly by pressing HDMI on the remote control.

Listening to Music/ Sound with the BLUETOOTH® Function

You can listen to music stored on a mobile device such as a smartphone or tablet via a wireless connection by connecting the system and mobile device with the BLUETOOTH function. When connecting to the mobile device with the BLUETOOTH function, you can operate by simply using the supplied remote control without turning the TV on.

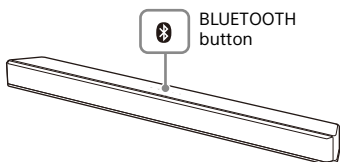
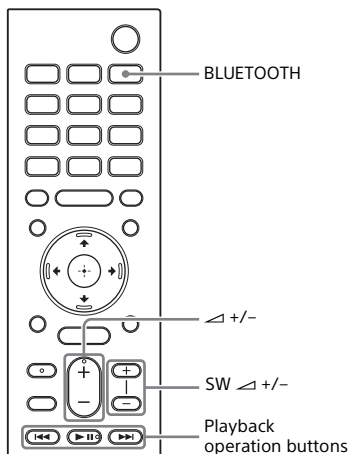

Listening to Music by Pairing the Mobile Device that is Connected for the First Time

To use the BLUETOOTH function, you need to perform pairing of the system and mobile device in advance.

1 Press and hold BLUETOOTH on the main unit for 2 seconds.

The system enters the pairing mode and the BLUETOOTH indicator flashes quickly.

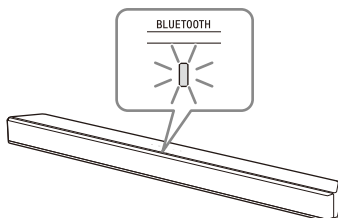

2 On the mobile device, search the system by performing the pairing operation.

The list of the BLUETOOTH devices that are searched appears on the screen of the mobile device. For the operation method to pair the BLUETOOTH device to the mobile device, refer to the operating instructions of the mobile device.

3 Pair the system and mobile device by selecting "HT-XF9000" from the list on the screen of the mobile device.

If a Passkey is requested, enter "0000."

4 Make sure that the BLUETOOTH indicator on the main unit lights in blue.

A connection between the system and mobile device has been established.

5 Start audio playback with the music app on the connected mobile device.

Sound is output from the main unit.

6 Adjust the volume.

- Adjust the volume by pressing \triangleleft +/- on the remote control.
- Adjust the subwoofer volume by pressing SW \triangleleft +/- on the remote control (page 35).
- You can play or pause the content by using the playback operation buttons on the remote control.

To check the connection status of the BLUETOOTH function

Status	BLUETOOTH indicator
During pairing standby status	Flashes quickly in blue
Connection is being attempted	Flashes in blue
Connection has been established	Lights in blue
The BLUETOOTH function is turned off	Flashes slowly in blue

Note

When the BLUETOOTH indicator flashes slowly in blue, the BLUETOOTH function is turned off. To use the BLUETOOTH function, set [Bluetooth Mode] to [Receiver] (page 48).

Tips

- If there is no mobile device that has been paired (ex. immediately after the purchase of the system), the system goes

into pairing mode simply by changing the input to the BLUETOOTH input.

- Perform pairing for the second and subsequent mobile devices.

Listening to Music from the Paired Device

1 Turn the BLUETOOTH function of the mobile device to on.

2 Press BLUETOOTH.

The system automatically reconnects to the mobile device it was most recently connected to.

3 Make sure that the BLUETOOTH indicator lights in blue.

A connection between the system and mobile device has been established.

4 Start audio playback with the music app on the connected mobile device.

Sound is output from the main unit.

5 Adjust the volume.

- Adjust the volume by pressing \triangleleft +/- on the remote control.
- Adjust the subwoofer volume by pressing SW \triangleleft +/- on the remote control (page 35).
- You can play or pause the content by using the playback operation buttons on the remote control.

To disconnect the mobile device

Perform any of the following items.

- Disable the BLUETOOTH function on the mobile device.
- Press BLUETOOTH while the [Bluetooth Audio] screen appears on the TV screen.
- Set [Bluetooth Mode] to [Off] (page 48).
- Turn off the system or mobile device.

Tip

When the connection is not established, select "HT-XF9000" on the mobile device.

Listening to Music on a USB Device

You can play music files stored on a connected USB device.

For playable types of files, see "Playable Types of Audio Files" (page 61).

- 1 Connect the USB device to the USB (USB) port.**

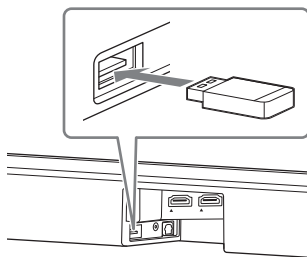

- 2 Press HOME.**

The home menu appears on the TV screen.
- 3 Select [Listen] - [USB (Connected)] on the home menu.**
- 4 Select the folder on which songs are stored, then select a song.**

The selected song is played and sound is output from the system.
- 5 Adjust the volume.**
 - Adjust the volume by pressing \triangleleft +/- on the remote control.
 - Adjust the subwoofer volume by pressing SW \triangleleft +/- on the remote control (page 35).

Note

Do not remove the USB device during operation. To avoid data corruption or damage to the USB device, turn the system off before connecting or removing the USB device.

About the Music Playback Screen

Select the following buttons on the screen by pressing ◀/▶, then press ⊕.

- ▶ (play)/⏸ (pause)
Starts or pauses playback. You can also operate by using ▶⏸ on the remote control.
- ⏮ (previous)/⏭ (next)
Plays the previous or next music file. You can also operate by using ⏮/⏭ on the remote control.
- 🔄 (Shuffle play)
Shuffles the playback order. Each time you press ⊕, on/off of the shuffle play is switched.
- 🔄 (Repeat play)
Press ⊕ repeatedly to switch the repeat mode.

Repeat mode	Explanation
🔄 (Repeat All)	Repeats all music files.
🔄 (Repeat Folder)	Repeats all music files in a folder.
🔄 1 (Repeat One)	Repeats a music file that is being played.
🔄 (Off)	Cancels the repeat play.

Tip

You can rewind/fast forward by pressing and holding ⏮/⏭ on the remote control during playback.

Listening to the Device Connected with an Analog Audio Cable

You can listen to sound of an audio device such as a TV, WALKMAN®, etc that is connected to the ANALOG IN jack on the system.

1 Press HOME.

The home menu appears on the TV screen.

2 Select [Listen] - [Analog] on the home menu.

The [Analog] screen is displayed on the TV screen.

3 Adjust the volume.

- Adjust the volume by pressing ▲ +/- on the remote control.
- Adjust the subwoofer volume by pressing SW ▲ +/- on the remote control (page 35).

Tip

You can also select [Analog] directly by pressing ANALOG.

Adjusting the Sound Quality

Enjoying Immersive Surround Experience (VERTICAL S.)

You can feel immersed by the sound from not only the horizontal direction, but also from the upward direction by using Vertical Surround Engine* effectively for sound modes (page 33) other than [News]. This function also works for the 2.0 channel signal such as a TV program.

* Vertical Surround Engine is a highly precise digital sound field processing technology developed by Sony that produces the sound field in the height direction virtually in addition to a sound field in the horizontal direction by only using front speakers and without using top speakers.

You do not need to install speakers on a ceiling and you can enjoy the sound with rich presence regardless of the ceiling height. Also, this function is hardly affected by the shape of a room because it does not use the sound reflected from a wall and enables improved surround playback.

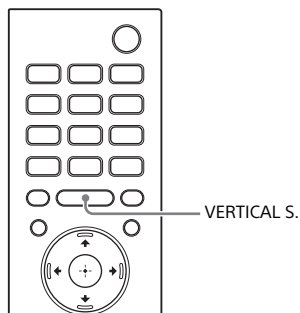

1 Press VERTICAL S.
The vertical surround setting appears on the TV screen.

2 Press the button repeatedly to select the setting.

Mode	Explanation
[On]	Activates the vertical surround function.
[Off]	Deactivates the vertical surround function.

Notes

- The surround effect from all directions differs depending on the sound source.
- The vertical surround setting does not appear on the TV screen while the TV input is selected.
- A time gap between the sound and picture may occur depending on the sound source. If your TV has a function that delays the image, use it for adjustment.

Setting the Sound Effect that is Tailored to Sound Sources (Sound Mode)

You can easily enjoy pre-programmed sound effects that are tailored to different kinds of sound sources.

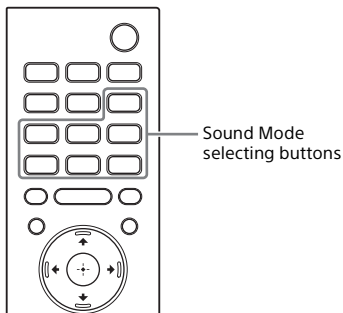

- 1 Press one of the sound mode selecting buttons (AUTO SOUND, CINEMA, MUSIC, GAME, NEWS, SPORTS, STANDARD) to select the sound mode.

The selected sound mode appears on the TV screen.

Sound mode	Explanation
[Auto Sound]	The appropriate sound setting is automatically selected for the sound source with ClearAudio+.
[Cinema]	You feel immersed by the sound that travels behind you and surrounds your entire body. This mode is suitable for watching movies.

Sound mode	Explanation
[Music]	Vividness and glossiness of the sound are expressed in detail. This mode is suitable for enjoying music in a way that moves you.
[Game Studio]	You can immerse yourself in your game by reproducing the feeling of movement and distance of objects, as well as clearly hearing the dialog.
[News]	Recreates the clear speech of newscasts.
[Sports]	You can experience an atmosphere as if you were watching an event in a stadium. However, narrations of commentators are reproduced vividly.
[Standard]	The sound of a TV program can be heard clearly.

Notes

- The sound mode function is disabled in the following conditions.
 - [Sound Effect] is set to a setting other than [Sound Mode On] (page 47).
 - Test tone is emitted (page 43).
- The sound mode does not appear on the TV screen while the TV input is selected.
- A time gap between the sound and picture may occur depending on the sound source. If your TV has a function that delays the image, use it for adjustment.

Making Dialogs Clearer (VOICE)

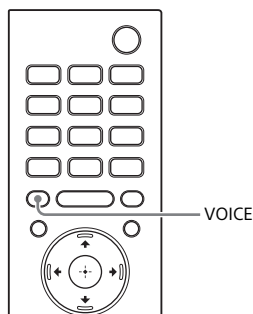

- 1 Press VOICE.**
The voice mode appears on the TV screen.
- 2 Press the button repeatedly to select the voice mode.**

Mode	Explanation
[Up Off]	Standard
[Up 1]	Dialog is easily heard by enhancing dialog range.
[Up 2]	Dialog range is enhanced, and dialog sound may be easy to hear for the elderly.

Note

The voice mode does not appear on the TV screen while the TV input is selected.

Enjoying Clear Sound with Low Volume at Midnight (NIGHT)

Sound is output at low volume with minimum loss of fidelity and clarity of dialog.

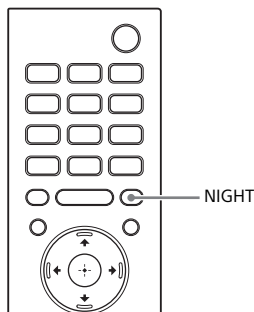

- 1 Press NIGHT.**
The night mode appears on the TV screen.
- 2 Press the button repeatedly to select the night mode.**

Mode	Explanation
[On]	Activates the night mode function.
[Off]	Deactivates the night mode function.

Notes

- When you turn the system off, this setting is set to [Off] automatically.
- The night mode does not appear on the TV screen while the TV input is selected.

Adjusting the Volume of the Subwoofer

The subwoofer is designed for playback of bass or low frequency sound.

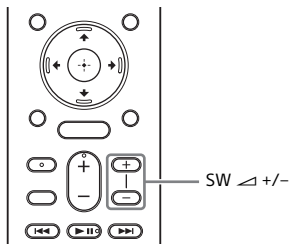

Press SW (subwoofer volume) ▲ +/- to adjust the volume of the subwoofer.

Note

When the input source does not contain much bass sound, such as in TV programs, the bass sound from the subwoofer may be difficult to hear.

Adjusting the Delay Between the Picture and Sound

When the sound does not match the pictures on the TV screen, you can adjust the delay between the picture and sound.

The setting method differs depending on the input.

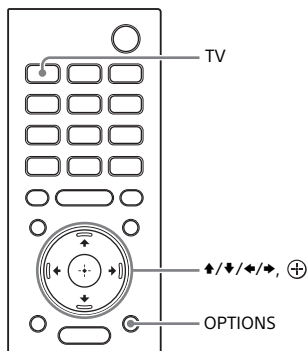

When Watching the TV

- 1 Press OPTIONS, then TV to enter the setting mode.**
The TV indicator flashes 3 times.
- 2 Adjust the delay using ▲/▼, then press ⊕.**
You can adjust from 0 msec to 300 msec in 25 msec increments.

The indicators flash according to the adjustment time.

- 0 msec: The TV and USB indicators flash twice.

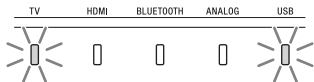

- 25 msec to 50 msec: The TV indicator flashes slowly twice.

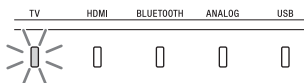

- 75 msec to 100 msec: The HDMI indicator flashes slowly twice.

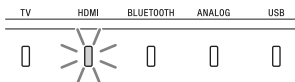

- 125 msec to 150 msec: The BLUETOOTH indicator flashes slowly twice.

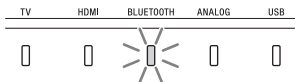

- 175 msec to 200 msec: The ANALOG indicator flashes slowly twice.

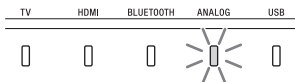

- 225 msec to 275 msec: The USB indicator flashes slowly twice.

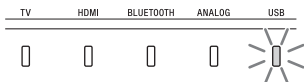

- 300 msec: The TV and USB indicators flash twice.

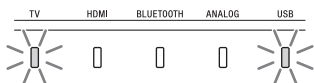

The TV indicator flashes 3 times and the setting value is decided.

When Watching Another Device

- 1 Press OPTIONS.**
The options menu appears on the TV screen.
- 2 Select [A/V Sync].**
- 3 Adjust the delay using \uparrow/\downarrow , then press \oplus .**
You can adjust from 0 msec to 300 msec in 25 msec increments.

Tip

If your TV has a function that adjusts the delay between the picture and sound, use it for adjustment. For details, refer to the operating instructions of the TV.

Playing Compressed Audio Files or CDs in Natural Sound Quality (DSEE)

This function enhances the sound quality of compressed audio files or CDs by restoring high-range sound removed in the compression process. You can enjoy listening to sound close to its original, natural, and spatial sound.

- 1 Press HOME.**
The home menu appears on the TV screen.
- 2 Select  [Setup] - [Advanced Settings] on the home menu.**
- 3 Select [Audio Settings] - [DSEE].**
- 4 Select [On].**

Notes

- This function is only available when [Auto Sound]* or [Music] is selected as the sound mode (page 33).
 - This function is compatible with the 2-channel digital input signals of 44.1 kHz or 48 kHz sampling frequency.
 - The sampling frequency/bit depth after upscaling is up to 96 kHz/24 bit.
 - This function is not compatible with DSD signals.
 - This function does not work when [Advanced Auto Volume] is set to [On] (page 47).
- * Only when [Music] is selected with [Auto Sound].

Enjoying Multiplex Broadcast Sound (AUDIO)

You can enjoy multiplex broadcast sound when the system receives a Dolby Digital multiplex broadcast signal.

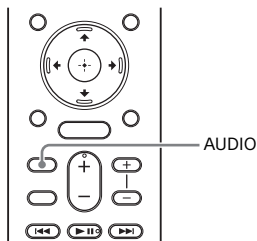

- 1 Press AUDIO repeatedly to select the desired audio signal.**

The indicators flash according to the setting.

- [Main]: The TV indicator flashes once.
Sound of the main language will be output.

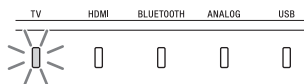

- [Sub]: The USB indicator flashes once.
Sound of the sub language will be output.

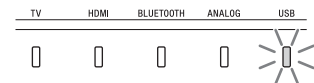

- [Main/Sub]: The TV and USB indicators flash once.
Mixed sound of both the main and sub languages will be output.

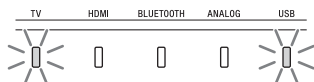

Notes

- To receive a Dolby Digital signal, you need to connect the TV that is compatible with eARC or ARC (page 41) to the HDMI OUT (TV eARC/ARC) jack with the HDMI cable (not supplied), or other devices to the HDMI IN jack with the HDMI cable (not supplied).
- If your TV's HDMI IN jack is not compatible with eARC or ARC (page 41), connect the TV to the TV IN (OPT) jack with the optical digital cable (supplied) to receive a Dolby Digital signal.

Adjusting the Dialog Volume While the DTS:X Content is Played Back

By adjusting the dialog volume, you can easily listen to dialog since it stands out from the ambient noise. This function works while playing content that is compatible with the DTS:X dialog control function.

The setting method differs depending on the input.

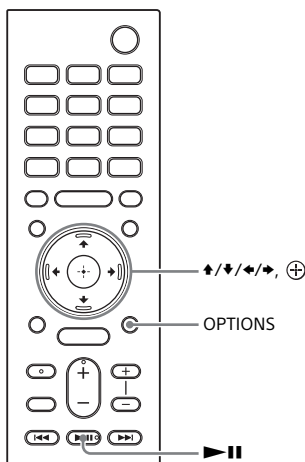

When Playing on the TV

- 1 Press OPTIONS, then ▶|| (play/pause).**
The TV indicator flashes 3 times.
- 2 Adjust the dialog volume using ▲/▼, then press ⊕.**
You can adjust from 0 dB to 6 dB in 1 dB increments.

The indicators flash according to the dialog volume.

- 0 dB: The TV and USB indicators flash twice.

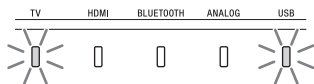

- 1 dB: The TV indicator flashes slowly twice.

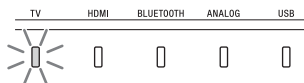

- 2 dB: The HDMI indicator flashes slowly twice.

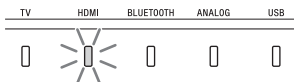

- 3 dB: The BLUETOOTH indicator flashes slowly twice.

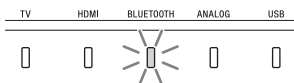

- 4 dB: The ANALOG indicator flashes slowly twice.

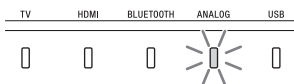

- 5 dB: The USB indicator flashes slowly twice.

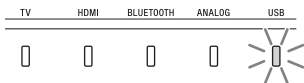

- 6 dB: The TV and USB indicators flash twice.

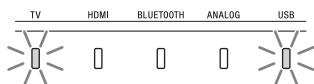

The TV indicator flashes 3 times and the setting value is set.

When Playing on the AV Device

1 Press **OPTIONS**.

The options menu appears on the TV screen.

2 Select **[Dialog Control]**.

3 Adjust the dialog volume using **↑/↓**, then press **+**.

You can adjust from 0 dB to 6 dB in 1 dB increments.

Using the Control for HDMI Function

Using the Control for HDMI Function

Connecting a device such as a TV or Blu-ray Disc player compatible with the Control for HDMI function* by an HDMI cable enables you to easily operate the device by a TV remote control. The following functions can be used with the Control for HDMI function.

- System Power Off function
- System Audio Control function
- eARC/ARC (Enhanced Audio Return Channel/Audio Return Channel)
- One-Touch Play function
- Menu Operation by TV Remote Control
- HDMI Standby Through power saving setting
- Language Follow

Note

These functions may work with devices other than those manufactured by Sony, but operation is not guaranteed.

* Control for HDMI is a standard used by CEC (Consumer Electronics Control) for allowing HDMI (High-Definition Multimedia Interface) devices to control each other.

Preparing to Use the Control for HDMI Function

Set  [Setup] - [Advanced Settings] - [HDMI Settings] - [Control for HDMI] on the system to [On] (page 47). The default setting is [On].

Enable the Control for HDMI function settings for the TV and other device connected to the system.

Tip

If you enable the Control for HDMI ("BRAVIA" sync) function when using a TV manufactured by Sony, the Control for HDMI function of the system is also enabled automatically.

System Power Off Function

When you turn off the TV, the system will turn off automatically.

Set  [Setup] - [Advanced Settings] - [HDMI Settings] - [Standby Linked to TV] on the system to [On] or [Auto] (page 47). The default setting is [Auto].

Note

The connected device may not turn off depending on the status of the device.

System Audio Control Function

If you turn on the system while you are watching the TV, the TV sound will be output from the speakers of the system. The volume of the system can be adjusted using the TV remote control. When you turn on the TV, the system is turned on automatically and the TV sound is output from the speakers of the system.

Operations can also be made by the TV's menu. For details, refer to the operating instructions of your TV.

Notes

- Depending on the settings of the TV, the System Audio Control function may not be available. For details, refer to the operating instructions of your TV.
- Depending on the TV, if the TV sound was output from the speakers of the TV the previous time you watched the TV, the system may not turn on by interlocking with the TV power even if the TV is turned on.

eARC/ARC (Enhanced Audio Return Channel/Audio Return Channel)

If the system is connected to a TV's HDMI IN jack compatible with eARC or ARC, you can listen to TV sound from the speakers of the system without connecting an optical digital cable. On the system, set  [Setup] - [Advanced Settings] - [HDMI Settings] - [TV Audio Input Mode] to [Auto] (page 48). The sound of eARC or ARC takes priority while set to [Auto]. The default setting is [Auto].

Notes

- Enable the eARC or ARC function of the TV. For details, refer to the operating instructions of the TV.
- If the TV is not compatible with eARC or ARC, the optical digital cable (supplied) needs to be connected (refer to the supplied Startup Guide).

One-Touch Play Function

When you play content on a device (Blu-ray Disc player, "PlayStation4," etc.) connected to the system, the system and TV are turned on automatically, the input of the system is switched to the input for the device played, and sound is output from the speakers of the system.

Notes

- If  [Setup] - [Advanced Settings] - [HDMI Settings] - [Standby Through] on the system is set to [On] or [Auto] and the TV sound was output from the speakers of the TV the previous time you watched the TV, the system may not turn on and the sound and picture may be output from the TV even if device content is played (page 48).
- Depending on the TV, the beginning part of content being played may not play correctly.

Menu Operation by TV Remote Control

You can select the system using the SYNC MENU button on the TV remote control and operate the system. This function can be used if the TV supports the Sync Menu. For details, refer to the operating instructions of your TV.

Notes

- In the TV's Sync Menu, the system is recognized by the TV as "Player."
- Some operations may not be available with some TVs.

HDMI Standby Through Power Saving Setting

HDMI Standby Through power saving setting (page 48) is a function that allows you to enjoy the sound and picture of a connected device without turning on the system.

Set  [Setup] - [Advanced Settings] - [HDMI Settings] - [Standby Through] to [Auto] (page 48). The default setting is [Auto].

Note

If the picture of a device connected to the system is not displayed on the TV, set [Standby Through] to [On]. If you connect a TV other than those manufactured by Sony, we recommend you to select this setting.

Language Follow

When you change the language for the on-screen display of the TV, the system's on-screen display language is also changed.

Using the “BRAVIA” Sync Function

In addition to the Control for HDMI function, you can also use the following functions on devices compatible with the “BRAVIA” sync function.

- Sound mode/Scene Select function
- Home Theatre Control

Note

These functions are proprietary functions of Sony. This function cannot operate with products other than those manufactured by Sony.

Sound mode/Scene Select Function

The sound mode of the system is automatically switched according to the setting of the TV’s Scene Select function or sound mode. For details, refer to the operating instructions of your TV.

Set the sound mode to [Auto Sound] (page 33).







Home Theatre Control Function

When using a TV compatible with the Home Theatre Control function, setting the system, setting the sound mode settings, input switching, etc. can be done without switching the TV input. This function can be used when the TV is connected to the Internet. For details, refer to the operating instructions of your TV.

Changing the Settings

Customizing the Speaker Settings for Surround Sound

To obtain a good surround sound, set the speaker distance from your listening position and their output level, etc. The default settings are underlined.

- 1 Press HOME.**
The home menu appears on the TV screen.
- 2 Select  [Setup] - [Advanced Settings] on the home menu.**
- 3 Select [Speaker Settings] - [Manual Speaker Settings].**
The [Manual Speaker Settings] screen appears on the TV screen.
- 4 Perform the speaker settings.**
Select the setting item from the following items by pressing / and , then set the value in accordance with the environment by pressing / and .

[Distance]

Set the distance from the listening position to the speakers. You can set the value from 0 meters to 10 meters (0.1 m step) (0 ft to 33 ft (1/4 ft step)).
[Front]: Sets the front speaker distance.
[Subwoofer]: Sets the subwoofer distance.

Tip

You can change measurement units (feet or meters) by pressing OPTIONS.

[Level]

Adjust the sound level of the speakers. You can set the value from -6.0 dB to 6.0 dB (0.5 dB step).
[Front]: Sets the front speaker level.
[Subwoofer]: Sets the subwoofer level.

[Test Tone]

The test tone is emitted from the speakers for checking the available speakers.
[Off]: The test tone is not emitted from the speakers.
[On]: The test tone is emitted from the speaker.

Changing the Brightness of the Indicators of the Indicators (DIMMER)

You can change the brightness of the indicators on the main unit.

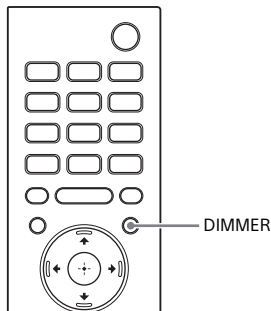

1 Press DIMMER.

The display mode appears on the TV screen.

2 Press the button repeatedly to select the desired display mode.

Mode	Explanation
[Bright]	All the indicators light brightly.
[Dark]	All the indicators light darkly.
[Off]	All the indicators are turned off.

Note

All the indicators on the main unit are turned off when [Off] is selected. They turn on automatically when you press any button, then turn off again if you do not operate the system for about 10 seconds. However, in some cases, the indicators may not turn off. In this case, the brightness of the indicators is same as [Dark].

Saving Power in Standby Mode

Check that you have made the following settings:

- [Bluetooth Standby] is set to [Off] (page 48).
- [Standby Through] is set to [Off] (page 48).

Performing Easy Setup

You can make basic initial settings for the system easily by performing Easy Setup.

- 1 Press HOME.**
The home menu appears on the TV screen.
- 2 Select  [Setup] - [Easy Setup] on the home menu.**
- 3 Perform settings by following the on-screen instructions.**

Performing Advanced Settings

You can make various adjustments to items such as picture and sound. The default settings are underlined.







1 Press HOME.

The home menu appears on the TV screen.

2 Select [Setup] - [Advanced Settings] on the home menu.

The [Advanced Settings] screen appears on the TV screen.

3 Select the setting item.

Setting item	Explanation
 [Speaker Settings]	Makes the speaker and subwoofer settings for installing and connections. (page 47)
 [Audio Settings]	Makes the audio output settings. (page 47)
 [HDMI Settings]	Makes the HDMI settings. (page 47)
 [Bluetooth Settings]	Makes detailed settings for the BLUETOOTH function. (page 48)
 [System Settings]	Makes the system-related settings. (page 49)
 [Resetting]	Resets the system to the factory default settings. (page 49)
 [Software Update]	Updates the software of the system. (page 50)

[Speaker Settings]

[Manual Speaker Settings]

You can perform the speaker settings to obtain the best possible surround sound. For details, see “Customizing the Speaker Settings for Surround Sound” (page 43).

[Secure Link]

You can make wireless connection securely for the subwoofer. For details, see “Performing the Wireless Connection of the Subwoofer (SECURE LINK)” (page 25).

[Audio Settings]

[DSEE]

This function is only available when [Auto Sound]* or [Music] is selected as the sound mode.

[On]: Enhances sound quality by restoring high-range sound (page 37).

[Off]: Off

* Only when [Music] is selected with [Auto Sound].

[Audio DRC]

You can compress the dynamic range of the sound track.

[Auto]: Automatically compresses sound encoded in Dolby TrueHD.

[On]: The system reproduces the dolby and DTS sound track with the kind of dynamic range that the recording engineer intended.

[Off]: No compression of dynamic range.

[Sound Effect]

You can select sound effects such as the sound mode.

[Sound Mode On]: Vertical Surround Engine enhances the surround and height speaker channels to create an

immersive and enveloping virtual surround effect such as sound mode (page 33) and vertical surround (page 32).

[Dolby Speaker Virtualizer]: Dolby Speaker Virtualizer enhances the surround and height speaker channels to create an immersive and enveloping virtual surround effect when you play Dolby format. Disables sound effects other than Dolby format.

[Off]: Disables the sound effects. Select this when you do not want to set the upper limit of sampling frequency.

[Advanced Auto Volume]

You can reduce the change of volume due to the input signal. This function is effective when the volume of a TV commercial is louder than that of the TV program.

[On]: Adjusts the volume automatically.

[Off]: Off

Note

This function is not suitable for listening to music.

[HDMI Settings]

[Control for HDMI]

[On]: The Control for HDMI function is enabled. Devices connected with an HDMI cable can control each other.

[Off]: Off

[Standby Linked to TV]

This function is available when you set [Control for HDMI] to [On].

[Auto]: If the input of the system is [TV] or [HDMI], the system turns off automatically when you turn off the TV. [On]: The system turns off automatically when you turn off the TV regardless of the input.

[Off]: The system does not turn off when you turn off the TV.

[Standby Through]

This function is available when you set [Control for HDMI] to [On].

[Auto]: Signals are output from the system's HDMI OUT (TV eARC/ARC) jack when the TV is turned on while the system is not turned on. The system standby power consumption can be reduced more than when set to [On] by turning off the connected TV.

[On]: Signals are always output from the system's HDMI OUT (TV eARC/ARC) jack when the system is not turned on. If you connect a TV other than those manufactured by Sony, we recommend that you select this setting.

[Off]: Signals are not output from the system's HDMI OUT (TV eARC/ARC) jack when the system is not turned on. Turn on the system to enjoy on the TV content of a device connected to the system. The system standby power consumption can be reduced more than when set to [On].

[TV Audio Input Mode]

Set this function when the system is connected to a TV's HDMI IN jack that is compatible with eARC or ARC. The eARC or ARC function is available when you set [Control for HDMI] to [On].

[Auto]: You can listen to TV sound from the speakers of the system. The sound of eARC or ARC takes priority while set to [Auto].

[Optical]: Use this setting when an optical digital cable is connected.

[eARC]

Set this function when the system is connected to a TV's HDMI IN jack that is compatible with eARC. When connecting to a TV compatible with ARC (not compatible with eARC), the ARC function works regardless of this setting.

[On]: Enables the eARC function. The eARC function works when connecting a TV compatible with eARC.

[Off]: Disables the eARC function.

Note

When [eARC] is set to [On], make sure of the eARC setting of the connected TV. For details, refer to the operating instructions of the TV.

[HDMI Signal Format]

You can select the HDMI signal format for the input signal. For details, see "Setting the HDMI Signal Format to Watch 4K Video Content" (page 21).

[Bluetooth Settings]

[Bluetooth Mode]

You can enjoy content from a BLUETOOTH device by using this system.

[Receiver]: This system is in receiver mode, which enables it to receive and output audio from the BLUETOOTH device.

[Off]: The BLUETOOTH function is turned off and you cannot select the [Bluetooth Audio] input.

[Bluetooth Standby]

You can set the [Bluetooth Standby] so that the system can be turned on by a BLUETOOTH device even when the system is in standby mode. This function is only available when you set [Bluetooth Mode] to [Receiver].

[On]: The system turns on automatically when you request a BLUETOOTH connection from a paired BLUETOOTH device.

[Off]: Off

[Bluetooth Codec - AAC]

This function is only available when you set [Bluetooth Mode] to [Receiver].

[On]: Enables AAC codec.

[Off]: Disables AAC codec.

Note

You can enjoy high-quality sound if AAC is enabled and your device supports AAC.

[System Settings]

[OSD Language]

You can select the language you want for the system on-screen display.

[IR-Repeater]

[On]: Remote signals for the TV are sent from the rear of the main unit.

[Off]: Turns off the function.

For details, see "When the TV Remote Control does not Work" (page 26).

[Auto Standby]

[On]: Turns on the [Auto Standby] function. When you do not operate the system while no signal is input for about 20 minutes, the system enters standby mode automatically.

[Off]: Off

[Device Name Setting]

You can change the name of this system according to your preference so that it is more recognizable when using the [Bluetooth Audio] function. Follow on-screen instructions and use the software keyboard to enter the name.

[Software License Information]

You can display the Software License Information.

[Software Version]

The software version is displayed.

[Resetting]

You can reset the system settings to the factory default by selecting the group of settings. All the settings within the group will be reset.

For details, see "Resetting the System" (page 57).

[Software Update]

You can update the software of the system. For details, see "Updating the Software" (page 50).

Updating the Software

By updating your software to the latest version, you can take advantage of the newest functions.

For information about update functions, visit the following website:

www.sony.eu/support

Notes

- The software is updated by using a USB memory.
- It may take up to 40 minutes for the update to be completed.
- While the updating operation is in progress, do not turn on or off the system, disconnect the AC power cord (mains lead), disconnect/connect the HDMI cable, or operate the system or TV. Wait for the software update to complete.

1 Press HOME.

The home menu appears on the TV screen.

2 Select [Setup] - [Advanced Settings] on the home menu.

3 Select [Software Update].

The updating proceeds as follows.

1 When a software update starts, all the indicators on the main unit flash 4 times quickly. Then the system automatically reboots.

2 During a software update, the indicators on the main unit flash. The flashing indicators increase from 1 to 5 associated with the updating progress.

3 After the update is complete, all the indicators on the main unit flash twice quickly, then the system automatically reboots.

Tip

You can perform [Software Update] by pressing and holding the BLUETOOTH and  button on the main unit for 7 seconds.

Troubleshooting

Troubleshooting

If you experience any of the following difficulties while using the system, use this troubleshooting guide to help remedy the problem before requesting repairs. Should any problem persist, consult your nearest Sony dealer. Be sure to bring both your main unit and subwoofer, even if it seems as though only one has a problem, when you request to repair.

Power

The system does not power up.

- Check that the AC power cord (mains lead) is connected securely.
- Disconnect the AC power cord (mains lead) from the wall outlet (mains), and then reconnect after several minutes.

The system does not turn on even when the TV is turned on.

- Set  [Setup] - [Advanced Settings] - [HDMI Settings] - [Control for HDMI] to [On] (page 47). The TV must support the Control for HDMI function (page 40). For details, refer to the operating instructions of your TV.
- Check the speaker settings of the TV. The system power syncs with the speaker settings of the TV. For details, refer to the operating instructions of your TV.
- Depending on the TV, if the sound was output from the speakers of the TV the previous time, the system may not turn on by interlocking with the TV power even when the TV is turned on.

The system turns off when the TV is turned off.

- Check the setting of  [Setup] - [Advanced Settings] - [HDMI Settings] - [Standby Linked to TV] (page 47). When [Standby Linked to TV] is set to [On] or [Auto], the system turns off automatically when you turn off the TV.

The system does not turn off even when the TV is turned off.

- Check the setting of  [Setup] - [Advanced Settings] - [HDMI Settings] - [Standby Linked to TV] (page 47). To turn the system off automatically regardless of the input when you turn off the TV, set [Standby Linked to TV] to [On]. The TV must support the Control for HDMI function (page 40). For details, refer to the operating instructions of your TV.

The system cannot be turned off.

- The system may be in demo mode. To cancel demo mode, reset the system. Press and hold  (power) and - (volume) on the main unit for more than 5 seconds (page 57).

Picture

There is no picture or the picture is not output correctly.

- Select the appropriate input (page 27).
- When there is no picture while the TV input is selected, select the TV channel that you want using the TV remote control.
- When there is no picture while the HDMI input is selected, press the playback button of the connected device.
- Disconnect the HDMI cable, then connect it again. Make sure that the cable is firmly inserted.

- When there is no picture from the connected device or the picture from the connected device is not output correctly, set  [Setup] - [Advanced Settings] - [HDMI Settings] - [HDMI Signal Format] - [HDMI IN] to [Standard format] (page 21).
- If you connect a device supporting HDCP 2.2, be sure to connect the device to the HDMI IN jack and the TV to the HDMI OUT (TV eARC/ARC) jack of the system.
- The system is connected to an input device that is not HDCP (High-bandwidth Digital Content Protection) compliant. In this case, check the specifications of the connected device.

3D content from the HDMI IN jack do not appear on the TV screen.

- Depending on the TV or video device, 3D content may not appear. Check the supported HDMI video format (page 63).



4K video content from the HDMI IN jack do not appear on the TV screen.

- Depending on the TV or the video device, 4K video content may not appear. Check the video capability and settings of your TV and video device.
- The picture may not be displayed properly if the [HDMI Signal Format] setting is changed. In this case, change the setting to [Standard format] (page 21).
- Use a Premium High Speed HDMI Cable with Ethernet that supports 18Gbps or High Speed HDMI Cable with Ethernet (page 63).

An image is not displayed on the entire TV screen.

- The aspect ratio on the media is fixed.

Picture and sound of the device that is connected to the system are not output from the TV when the system is not turned on.

- Set  [Setup] - [Advanced Settings] - [HDMI Settings] - [Control for HDMI] to [On] on the system, and then set [Standby Through] to [Auto] or [On] (page 48).
- Turn on the system, and then switch the input for the device playing.
- If connected to devices other than those manufactured by Sony that support the Control for HDMI function, set  [Setup] - [Advanced Settings] - [HDMI Settings] - [Standby Through] to [On] (page 48).

HDR contents cannot show as high-dynamic range.

- Check the settings of the TV and connected device. For details, refer to the operating instructions of your TV and the connected device.
- Some devices may convert HDR contents to SDR if the bandwidth is not enough. In that case, set  [Setup] - [Advanced Settings] - [HDMI Settings] - [HDMI Signal Format] - [HDMI IN] to [Enhanced format] if the TV and the connected device support a bandwidth of up to 18Gbps (page 21). When you select [Enhanced format], be sure to use a Premium High Speed HDMI Cable with Ethernet that supports 18Gbps (page 63).

Sound

The system cannot connect to a TV with the BLUETOOTH function.

- When you connect the system and TV with an HDMI cable (not supplied), the BLUETOOTH connection is canceled.



No TV sound is output from the system.

- Check the type and connection of the HDMI cable, optical digital cable, or analog audio cable that is connected to the system and the TV (refer to the supplied Startup Guide).
- Disconnect the cables that are connected between the TV and the system, then connect them firmly again. Disconnect the AC power cords (mains leads) of the TV and the system from the AC outlets (mains), then connect them again.
- When the system and TV are connected with an HDMI cable, check the following.
 - The HDMI jack of the connected TV is labeled with “eARC” or “ARC.”
 - The Control for HDMI function of the TV is set to on.
 - The eARC or ARC function of the TV is enabled.
 - On the system, [Control for HDMI] is set to [On] and [TV Audio Input Mode] to [Auto] (page 48).
- If your TV is not compatible with eARC, set  [Setup] - [Advanced Settings] - [HDMI Settings] - [eARC] to [Off] (page 48).
- If your TV is not compatible with eARC or ARC, connect the optical digital cable (supplied) (refer to the supplied Startup Guide). If the TV is not compatible with eARC or ARC, TV sound will not be output from the system even if the system is connected to the TV's HDMI IN jack.
- Switch the input of the system to the TV input. When you connect the system and TV with an analog audio cable (not supplied), switch input of the system to the ANALOG input (page 31).
- Increase the volume on the system or cancel muting.
- If sound of a cable box/satellite box connected to the TV is not output, connect the device to a HDMI IN jack

of the system and switch input of the system to [HDMI] (refer to the supplied Startup Guide).

- Depending on the order in which you connect the TV and the system, the system may be muted and the TV and USB indicators flash slowly. If this happens, turn on the TV first, then the system.
- Set the speakers setting of the TV (BRAVIA) to Audio System. Refer to the operating instructions of your TV regarding how to set the TV.

Picture and sound of the device that is connected to the system are not output from the TV when the system is not turned on.

- Set  [Setup] - [Advanced Settings] - [HDMI Settings] - [Control for HDMI] to [On] on the system, and then set [Standby Through] to [Auto] or [On] (page 48).
- Turn on the system, and then switch the input for the device playing.
- If connected to devices other than those manufactured by Sony that support the Control for HDMI function, set  [Setup] - [Advanced Settings] - [HDMI Settings] - [Standby Through] to [On] (page 48).

The sound is output from both the system and TV.

- Mute the sound of the system or TV.





The sound is interrupted while watching a TV program or content on a Blu-ray Disc, etc.

- Check the sound mode setting (page 33). If the sound mode is set to [Auto Sound], the sound may be interrupted when the sound mode is changed automatically according to the information of the program that is being played. If you do not want to change the sound mode automatically, set the sound mode to a setting other than [Auto Sound].

The TV sound from this system lags behind the image.

- Set the adjustment value of the delay between the picture and sound to 0 msec if it is set to the range between 25 msec and 300 msec (page 35).
- A time gap between the sound and picture may occur depending on the sound source. If your TV has a function that delays the image, use it for adjustment.

No sound or only a very low-level sound of the device connected to the system is heard.

- Press  + on the remote control and check the volume level (page 11).
- Press  or  + on the remote control to cancel the muting function (page 11).
- Make sure the input source is selected correctly. You should try other input sources by pressing the input select button on the remote control (TV/HDMI/ANALOG/USB/BLUETOOTH) (page 11).
- Check that all the cables and cords of the system and connected device are firmly inserted.
- When you play content compatible with copyright protection technology (HDCP), it may not be output from the system.
- Set  [Setup] - [Advanced Settings] - [HDMI Settings] - [HDMI Signal Format] to [Standard format] (page 21).



The surround effect cannot be obtained.

- Depending on the input signal and the sound mode setting, surround sound processing may not work effectively. The surround effect may be subtle, depending on the program or disc.
- To play multi-channel audio, check the digital audio output setting on the device connected to the system.

For details, refer to the operating instructions supplied with the connected device.

Subwoofer

No sound or only a very low-level sound is heard from the subwoofer.

- Press SW  + on the remote control to increase the subwoofer volume (page 35).
- Make sure that the power indicator on the subwoofer is lit in green or amber.
- If the power indicator on the subwoofer does not light, try the following.
 - Make sure the AC power cord (mains lead) of the subwoofer is connected properly.
 - Press  (power) of the subwoofer to turn on the power.
- If the power indicator on the subwoofer flashes slowly in green or amber, or lights in red, try the following.
 - Move the subwoofer to a location near the main unit so that the power indicator on the subwoofer lights in green or amber.
 - Follow the steps in "Performing the Wireless Connection of the Subwoofer (SECURE LINK)" (page 25).
- If the power indicator on the subwoofer flashes in red, press  (power) of the subwoofer to turn off the power and check whether the ventilation holes of the subwoofer is blocked or not.
- If the input sources contain very little bass sound components (i.e., a TV broadcast), the sound from the subwoofer may be difficult to hear. You can check the subwoofer sound by emitting the test tone (page 43).
- Set the night mode to off. For details, see "Enjoying Clear Sound with Low

Volume at Midnight (NIGHT)"
(page 34).

Sound skips or has noise.

- If there is a device nearby that generates electromagnetic waves, such as a wireless LAN or a microwave oven in use, locate the system apart from it.
- If there is an obstacle between the main unit and the subwoofer, move or remove it.
- Do not cover the top of the Bar Speaker with metal objects such as TV frame, etc. Wireless functions may become unstable.
- Locate the main unit and the subwoofer as close as possible.
- Switch the wireless LAN frequency of any nearby wireless LAN router or PC to 5 GHz range.
- Switch the network connection of the TV or Blu-ray Disc player from wireless to wired.

USB Device Connection

The USB device is not recognized.

- Try the following:
 - ① Turn the system off.
 - ② Remove and reconnect the USB device.
 - ③ Turn the system on.
- Make sure that the USB device is securely connected to the  (USB) port (page 30).
- Check to see if the USB device or a cable is damaged.
- Make sure that the USB device is on.
- If the USB device is connected via a USB hub, disconnect it and connect the USB device directly to the system.
- When connecting a WALKMAN® or smartphone, its internal storage or external storage (such as a memory card) may not be recognized.

Mobile Device Connection

Pairing cannot be achieved.

- Bring this system and the BLUETOOTH device closer together.
- Make sure this system is not receiving interference from a wireless LAN device, other 2.4 GHz wireless devices, or a microwave oven. If a device that generates electromagnetic radiation is nearby, move the device away from this system.

BLUETOOTH connection cannot be completed.

- Make sure that the BLUETOOTH indicator of the main unit is lit (page 29).
- Make sure the BLUETOOTH device to be connected with is turned on and the BLUETOOTH function is enabled.
- Bring this system and the BLUETOOTH device closer together.
- Pair this system and the BLUETOOTH device again. You may need to cancel the pairing with this system using your BLUETOOTH device first.
- Pairing information may be deleted. Perform pairing operation again (page 28).

Sound of the connected BLUETOOTH mobile device is not output from the system.

- Make sure that the BLUETOOTH indicator of the main unit is lit (page 29).
- Bring this system and the BLUETOOTH device closer together.
- If a device that generates electromagnetic radiation, such as a wireless LAN device, other BLUETOOTH devices, or a microwave oven is nearby, move the device away from this system.
- Remove any obstacle between this system and the BLUETOOTH device or

- move this system away from the obstacle.
- Reposition the connected BLUETOOTH device.
 - Switch the wireless LAN frequency of any nearby wireless LAN router or PC to 5 GHz range.
 - Increase the volume on the connected BLUETOOTH device.

Remote Control

The remote control of this system does not function.

- Point the remote control at the remote control sensor on the main unit (page 8).
- Remove any obstacles in the path between the remote control and the system.
- Replace both batteries in the remote control with new ones, if they are weak.
- Make sure you are pressing the correct button on the remote control.

TV remote control does not work.

- This problem might be solved by enabling the IR repeater function (page 26).

Others

The Control for HDMI function does not work properly.

- Check the connection with the system (refer to the supplied Startup Guide).
- Enable the Control for HDMI function on the TV. For details, refer to the operating instructions of your TV.
- Wait a while, and then try again. If you unplug the system, it will take a while before operations can be made. Wait for 15 seconds or longer, and then try again.

- Make sure the devices connected to the system support the Control for HDMI function.
- Enable the Control for HDMI function on the devices connected to the system. For details, refer to the operating instructions of your device.
- The type and number of devices that can be controlled by the Control for HDMI function is restricted by the HDMI CEC standard as follows:
 - Recording devices (Blu-ray Disc recorder, DVD recorder, etc.): up to 3 devices
 - Playback devices (Blu-ray Disc player, DVD player, etc.): up to 3 devices (this system uses one of them)
 - Tuner-related devices: up to 4 devices
 - Audio system (receiver/headphones): up to 1 device (used by this system)

All the indicators flash quickly and the system is turned off.

- Disconnect the AC power cord (mains lead) and make sure nothing is obstructing the ventilation holes of the system.

Sensors of the TV do not work properly.

- The main unit may block some sensors (such as the brightness sensor), the remote control receiver of your TV or the emitter for 3D glasses (infrared transmission) of a 3D TV that supports the infrared 3D glass system, or wireless communication. Move the main unit away from the TV within a range that allow those parts to operate properly. For the locations of the sensors and remote control receiver, refer to the operating instructions supplied with the TV.



Wireless functions (the BLUETOOTH function or subwoofer) are unstable.

→ Do not place metal objects other than a TV around the system.

Music that you are not familiar with suddenly plays.

→ The pre-installed sample music may have been played. Press  on the main unit to stop playback.

The system cannot be turned off or [Advanced Settings] cannot be used./When pressing , all the indicators flash and the system cannot be turned off.

→ The system may be in demo mode. To cancel demo mode, reset the system. Press and hold  (power) and  (volume) on the main unit for more than 5 seconds (page 57).

The system restarts.

→ When connecting to a TV with a resolution that is different from that of the system, the system may restart to reset the picture output setting.

Resetting the System



If the system still does not operate properly, reset the system as follows.

- 1 Press HOME.**
The home menu appears on the TV screen.
- 2 Select  [Setup] - [Advanced Settings] on the home menu.**
- 3 Select [Resetting].**
- 4 Select the menu item you want to reset.**
- 5 Select [Start].**

To cancel resetting

Select [Cancel] in step 5.

If You Cannot Perform Resetting Using the Home Menu

Press and hold  (power) and  (volume) on the main unit for more than 5 seconds.

The settings return to their initial status.

Note

By resetting, the link with the subwoofer may be lost. In this case, perform "Performing the Wireless Connection of the Subwoofer (SECURE LINK)" (page 25).

Additional Information

Specifications

Bar Speaker (SA-XF9000)

Amplifier section

POWER OUTPUT (rated)

Front L + Front R: 60 W + 60 W
(at 4 ohms, 1 kHz, 1% THD)

POWER OUTPUT (reference)

Front L/Front R speaker blocks: 100 W
(per channel at 4 ohms, 1 kHz)

Inputs

HDMI IN*
ANALOG IN
TV IN (OPT)

Outputs

HDMI OUT (TV eARC/ARC)*

* HDMI IN and HDMI OUT (TV eARC/ARC) jacks support HDCP 2.2 protocol. HDCP 2.2 is newly enhanced copyright protection technology that is used to protect content such as 4K movies.

HDMI Section

Connector

Type A (19pin)

USB section

⚡ (USB) port:

Type A (For connecting USB memory)

BLUETOOTH section

Communication system

BLUETOOTH Specification version 4.2

Output

BLUETOOTH Specification Power
Class 1

Maximum communication range

Line of sight approx. 30 m¹⁾

Maximum number of devices to be

registered
9 devices

Frequency band

2.4 GHz band (2.4 GHz - 2.4835 GHz)

Modulation method

FHSS (Freq Hopping Spread Spectrum)

Compatible BLUETOOTH profiles²⁾

A2DP (Advanced Audio Distribution
Profile)

AVRCP (Audio Video Remote Control
Profile)

Supported Codecs³⁾

SBC⁴⁾, AAC⁵⁾

Transmission range (A2DP)

20 Hz - 20,000 Hz (Sampling frequency
32 kHz, 44.1 kHz, 48 kHz)

- 1) The actual range will vary depending on factors such as obstacles between devices, magnetic fields around a microwave oven, static electricity, cordless phone use, reception sensitivity, the operating system, software applications, etc.
- 2) BLUETOOTH standard profiles indicate the purpose of BLUETOOTH communication between devices.
- 3) Codec: Audio signal compression and conversion format
- 4) Abbreviation for Subband Codec
- 5) Abbreviation for Advanced Audio Coding

Front L/Front R speaker block section

Speaker system

Full Range speaker system, Acoustic
suspension

Speaker

40 mm × 100 mm cone type

General

Power requirements

220 V - 240 V AC, 50 Hz/60 Hz

Power consumption

On: 38 W

[Bluetooth Standby] - [On]: Less than
2 W

[Bluetooth Standby] - [Off]: Less than
0.5 W*

* When [Standby Through] is set to
[Off], or [Standby Through] is set to
[Auto] while the connected TV is
turned off.

Dimensions* (approx.) (w/h/d)

930 mm × 58 mm × 85 mm

*Not including projection portion

Mass (approx.)
2.5 kg

Subwoofer (SA-WXF9000)

POWER OUTPUT (reference)

100 W (at 4 ohms, 100 Hz)

Speaker system

Subwoofer speaker system, Bass
reflex

Speaker

160 mm cone type

Power requirements

220 V - 240 V AC, 50 Hz/60 Hz

Power consumption

On: 20 W

Standby mode: 0.5 W or less

Dimensions (approx.) (w/h/d)

190 mm × 382 mm × 387 mm (not
including projection portion)

Mass (approx.)

7.8 kg

Wireless Transmitter/ Receiver Section

Frequency band

2.4 GHz (2.4000 GHz - 2.4835 GHz)

Modulation method

FHSS (Freq Hopping Spread Spectrum)

Design and specifications are subject to
change without notice.

Radio Frequency Bands and Maximum Output Power

	Frequency band	Maximum output power
BLUETOOTH	2400 - 2483.5 MHz	< 9 dBm
Wireless Subwoofer	2400 - 2483.5 MHz	< 9 dBm

Playable Types of Audio Files

Codec	Extension
MP3 (MPEG-1 Audio Layer III)	.mp3
AAC/HE-AAC	.m4a, .aac, .mp4, .3gp
WMA9 Standard	.wma
LPCM	.wav
FLAC	.flac
DSF	.dsf
DSDIFF[*]	.dff
AIFF	.aiff, .aif
ALAC	.m4a
Vorbis	.ogg
Monkey's Audio	.ape

* The system does not play DST encoded files.

Notes

- Some files may not play depending on the file format, file encoding, recording condition, or other conditions.
- Some files edited on a PC may not play.
- Fast forward or fast reverse may not be available with some files.
- The system does not play coded files such as DRM.
- The system cannot recognize a file/folder depending on the name/meta-data.
- Some USB devices may not work with this system.
- The system can recognize Mass Storage Class (MSC) devices (such as flash memory).

Supported Input Audio Formats

Audio formats supported by this system are as follows.

Format	Function			
	"HDMI"	"TV" (eARC)	"TV" (ARC)	"TV" (OPT)
LPCM 2ch	○	○	○	○
LPCM 5.1ch	○	○	-	-
LPCM 7.1ch	○	○	-	-
Dolby Digital	○	○	○	○
Dolby TrueHD	○	○	-	-
Dolby Digital Plus	○	○	○	-
Dolby Atmos - Dolby TrueHD	○	○	-	-
Dolby Atmos - Dolby Digital Plus	○	○	○	-
DTS	○	○	○	○
DTS-ES Discrete 6.1, DTS-ES Matrix 6.1	○	○	○	○
DTS 96/24	○	○	○	○
DTS-HD High Resolution Audio	○	○	-	-
DTS-HD Master Audio	○	○	-	-
DTS-HD LBR	○	○	-	-
DTS:X	○	○	-	-
DSD	○	-	-	-

○: Supported format.

-: Unsupported format.

Note

The HDMI IN jack does not support audio format that contains copy protections, such as Super Audio CD or DVD-Audio.

Supported HDMI Video Formats

Video formats supported by this system are as follows.

Resolution	Frame Rate	3D	Color Space	Color Depth	[HDMI Signal Format] setting
4K 4096 × 2160p ³⁾ 3840 × 2160p	50/59.94/60 Hz	–	RGB 4:4:4 YCbCr 4:4:4	8 bit	[Enhanced format] ¹⁾
		–	YCbCr 4:2:2	8/10/12 bit	
	–	YCbCr 4:2:0	10/12 bit		
	23.98/24/25/29.97/30 Hz	–	RGB 4:4:4 YCbCr 4:4:4	10/12 bit	
4K 4096 × 2160p ³⁾ 3840 × 2160p	50/59.94/60 Hz	–	YCbCr 4:2:0	8 bit	[Standard format] ²⁾
	23.98/24/25/29.97/30 Hz	–	RGB 4:4:4 YCbCr 4:4:4	8 bit	
		–	YCbCr 4:2:2	8/10/12 bit	
1920 × 1080p	25/29.97/30/50/ 59.94/60 Hz	–	RGB 4:4:4 YCbCr 4:4:4 YCbCr 4:2:2	8/10/12 bit	
	23.98/24 Hz	⊙			
1920 × 1080i	50/59.94/60 Hz	○			
1280 × 720p	50/59.94/60 Hz	⊙			
	23.98/24/29.97/30 Hz	–			
720 × 480p	59.94/60 Hz	–			
720 × 576p	50 Hz	–			
640 × 480p	59.94/60 Hz	–	RGB 4:4:4		

○: Compatible with 3D signal in Side-by-Side (Half)³⁾ format

⊙: Compatible with 3D signal in Frame packing and Over-Under (Top-and-Bottom)³⁾ format

- 1) Use a Premium High Speed HDMI Cable with Ethernet that supports 18Gbps.
- 2) Use a Premium High Speed HDMI Cable with Ethernet or Sony High Speed HDMI Cable with Ethernet with the Cable Type Logo.
- 3) The OPTIONS button does not work and the On-Screen Display (OSD) of the system is not displayed.

Notes on HDMI Jack and HDMI Connections

- Use an HDMI-authorized cable.
- We do not recommend using an HDMI-DVI conversion cable.
- Audio signals (sampling frequency, bit length, etc.) transmitted from an HDMI jack may be suppressed by the connected device.
- Sound may be interrupted when the sampling frequency or the number of channels of audio output signals from the playback device is switched.

- When the TV input is selected, video signals via the HDMI IN jack selected last time are output from the HDMI OUT (TV eARC/ARC) jack.
- This system supports "TRILUMINOS."
- All HDMI IN and HDMI OUT (TV eARC/ARC) jacks support bandwidth up to 18Gbps, HDCP 2.2¹⁾, BT.2020 wide color spaces²⁾, and HDR (High Dynamic Range)³⁾ contents pass-through.
- When connecting to a TV with a resolution that is different from that of the system, the system may restart to reset the picture output setting.
 - ¹⁾ HDCP 2.2 is newly enhanced copyright protection technology that is used to protect content such as 4K movies.
 - ²⁾ BT.2020 color space is new wider color standard that is defined for ultra-high definition television systems.
 - ³⁾ HDR is an emerging video format that can display a wider range of brightness levels. The system is compatible with HDR10, HLG (Hybrid Log-Gamma), and Dolby Vision.

On BLUETOOTH Communication

- BLUETOOTH devices should be used within approximately 10 meters (33 feet) (unobstructed distance) of each other. The effective communication range may become shorter under the following conditions.
 - When a person, metal object, wall or other obstruction is between the devices with a BLUETOOTH connection
 - Locations where a wireless LAN is installed
 - Around microwave ovens that are in use
 - Locations where other electromagnetic waves occur
- BLUETOOTH devices and wireless LAN (IEEE 802.11 b/g/n) use the same frequency band (2.4 GHz). When using your BLUETOOTH device near a device with wireless LAN capability, electromagnetic interference may occur. This could result in lower data transfer rates, noise, or inability to connect. If this happens, try the following remedies:
 - Use this system at least 10 meters (33 feet) away from the wireless LAN device.
 - Turn off the power to the wireless LAN device when using your BLUETOOTH device within 10 meters (33 feet).
 - Install this system and BLUETOOTH device as closer to each other as possible.
- The radio waves broadcast by this system may interfere with the operation of some medical devices. Since this interference may result in malfunction, always turn off the power on this system and BLUETOOTH device in the following locations:
 - In hospitals, on trains, in airplanes, at gas stations, and any place where flammable gasses may be present
 - Near automatic doors or fire alarms
- This system supports security functions that comply with the BLUETOOTH specification to ensure secure connection

during communication using BLUETOOTH technology. However, this security may be insufficient depending on the setting content and other factors, so always be careful when performing communication using BLUETOOTH technology.

- Sony cannot be held liable in any way for damages or other loss resulting from information leaks during communication using BLUETOOTH technology.
- BLUETOOTH communication is not necessarily guaranteed with all BLUETOOTH devices that have the same profile as this system.
- BLUETOOTH devices connected with this system must comply with the BLUETOOTH specification prescribed by the Bluetooth SIG, Inc., and must be certified to comply. However, even when a device complies with the BLUETOOTH specification, there may be cases where the characteristics or specifications of the BLUETOOTH device make it impossible to connect, or may result in different control methods, display or operation.
- Noise may occur or the audio may cut off depending on the BLUETOOTH device connected with this system, the communications environment, or surrounding conditions.

If you have any questions or problems concerning your system, please consult your nearest Sony dealer.

END USER LICENSE AGREEMENT

IMPORTANT:

BEFORE USING THE SOFTWARE, PLEASE READ THIS END USER LICENSE AGREEMENT (“EULA”) CAREFULLY. BY USING THE SOFTWARE YOU ARE ACCEPTING THE TERMS OF THIS EULA. IF YOU DO NOT ACCEPT THE TERMS OF THIS EULA, YOU MAY NOT USE THE SOFTWARE.

This EULA is a legal agreement between you and Sony Video & Sound Products Inc. (“SONY”). This EULA governs your rights and obligations regarding the SONY software of SONY and/or its third party licensors (including SONY’s affiliates) and their respective affiliates (collectively, the “THIRD-PARTY SUPPLIERS”), together with any updates/upgrades provided by SONY, any printed, on-line or other electronic documentation for such software, and any data files created by operation of such software (collectively, the “SOFTWARE”).

Notwithstanding the foregoing, any software in the SOFTWARE having a separate end user license agreement (including, but not limited to, GNU General Public license and Lesser/Library General Public License) shall be covered by such applicable separate end user license agreement in lieu of the terms of this EULA to the extent required by such separate end user license agreement (“EXCLUDED SOFTWARE”).

SOFTWARE LICENSE

The SOFTWARE is licensed, not sold. The SOFTWARE is protected by copyright and other intellectual property laws and international treaties.

COPYRIGHT

All right and title in and to the SOFTWARE (including, but not limited to, any images, photographs, animation, video, audio, music, text and “applets” incorporated into the SOFTWARE) is owned by SONY or one or more of the THIRD-PARTY SUPPLIERS.

GRANT OF LICENSE

SONY grants you a limited license to use the SOFTWARE solely in connection with your compatible device (“DEVICE”) and only for your individual, non-commercial use. SONY and the THIRD-PARTY SUPPLIERS expressly reserve all rights, title and interest (including, but not limited to, all intellectual property rights) in and to the SOFTWARE that this EULA does not specifically grant to you.

REQUIREMENTS AND LIMITATIONS

You may not copy, publish, adapt, redistribute, attempt to derive source code, modify, reverse engineer, decompile, or disassemble any of the SOFTWARE, whether in whole or in part, or create any derivative works from or of the SOFTWARE unless such derivative works are intentionally facilitated by the SOFTWARE. You may not modify or tamper with any digital rights management functionality of the SOFTWARE. You may not bypass, modify, defeat or circumvent any of the functions or protections of the SOFTWARE or any mechanisms operatively linked to the SOFTWARE. You may not separate any individual component of the SOFTWARE for use on more than one DEVICE unless expressly authorized to do so by SONY. You may not remove, alter, cover or deface any trademarks or notices on the SOFTWARE. You may not share, distribute, rent, lease, sublicense, assign, transfer or sell the SOFTWARE.

The software, network services or other products other than SOFTWARE upon which the SOFTWARE'S performance depends might be interrupted or discontinued at the discretion of the suppliers (software suppliers, service suppliers, or SONY). SONY and such suppliers do not warrant that the SOFTWARE, network services, contents or other products will continue to be available, or will operate without interruption or modification.

USE OF SOFTWARE WITH COPYRIGHTED MATERIALS

The SOFTWARE may be capable of being used by you to view, store, process and/or use content created by you and/or third parties. Such content may be protected by copyright, other intellectual property laws, and/or agreements. You agree to use the SOFTWARE only in compliance with all such laws and agreements that apply to such content. You acknowledge and agree that SONY may take appropriate measures to protect the copyright of content stored, processed or used by the SOFTWARE. Such measures include, but are not limited to, counting the frequency of your backup and restoration through certain SOFTWARE features, refusal to accept your request to enable restoration of data, and termination of this EULA in the event of your illegitimate use of the SOFTWARE.

CONTENT SERVICE

PLEASE ALSO NOTE THAT THE SOFTWARE MAY BE DESIGNED TO BE USED WITH CONTENT AVAILABLE THROUGH ONE OR MORE CONTENT SERVICES ("CONTENT SERVICE"). USE OF THE SERVICE AND THAT CONTENT IS SUBJECT TO THE TERMS OF SERVICE OF THAT CONTENT SERVICE. IF YOU DECLINE TO ACCEPT THOSE TERMS, YOUR USE OF THE SOFTWARE WILL BE LIMITED. You acknowledge and agree

that certain content and services available through the SOFTWARE may be provided by third parties over which SONY has no control. USE OF THE CONTENT SERVICE REQUIRES AN INTERNET CONNECTION. THE CONTENT SERVICE MAY BE DISCONTINUED AT ANY TIME.

INTERNET CONNECTIVITY AND THIRD PARTY SERVICES

You acknowledge and agree that access to certain SOFTWARE features may require an Internet connection for which you are solely responsible. Further, you are solely responsible for payment of any third party fees associated with your Internet connection, including but not limited to Internet service provider or airtime charges. Operation of the SOFTWARE may be limited or restricted depending on the capabilities, bandwidth or technical limitations of your Internet connection and service. The provision, quality and security of such Internet connectivity are the sole responsibility of the third party providing such service.

EXPORT AND OTHER REGULATIONS

You agree to comply with all applicable export and re-export restrictions and regulations of the area or country in which you reside, and not to transfer, or authorize the transfer, of the SOFTWARE to a prohibited country or otherwise in violation of any such restrictions or regulations.

HIGH RISK ACTIVITIES

The SOFTWARE is not fault-tolerant and is not designed, manufactured or intended for use or resale as on-line control equipment in hazardous environments requiring fail-safe performance, such as in the operation of nuclear facilities, aircraft navigation or communication systems, air traffic

control, direct life support machines, or weapons systems, in which the failure of the SOFTWARE could lead to death, personal injury, or severe physical or environmental damage ("HIGH RISK ACTIVITIES"). SONY, each of the THIRD-PARTY SUPPLIERS, and each of their respective affiliates specifically disclaim any express or implied warranty, duty or condition of fitness for HIGH RISK ACTIVITIES.

EXCLUSION OF WARRANTY ON SOFTWARE

You acknowledge and agree that use of the SOFTWARE is at your sole risk and that you are responsible for use of the SOFTWARE. The SOFTWARE is provided "AS IS," without warranty, duty or condition of any kind.

SONY AND EACH OF THE THIRD-PARTY SUPPLIERS (for purposes of this Section, SONY and each of the THIRD-PARTY SUPPLIERS shall be collectively referred to as "SONY") EXPRESSLY DISCLAIM ALL WARRANTIES, DUTIES OR CONDITIONS, EXPRESS OR IMPLIED, INCLUDING, BUT NOT LIMITED TO, THE IMPLIED WARRANTIES OF MERCHANTABILITY, NONINFRINGEMENT AND FITNESS FOR A PARTICULAR PURPOSE. SONY DOES NOT WARRANT OR MAKE ANY CONDITIONS OR REPRESENTATIONS (A) THAT THE FUNCTIONS CONTAINED IN ANY OF THE SOFTWARE WILL MEET YOUR REQUIREMENTS OR THAT THEY WILL BE UPDATED, (B) THAT THE OPERATION OF ANY OF THE SOFTWARE WILL BE CORRECT OR ERROR-FREE OR THAT ANY DEFECTS WILL BE CORRECTED, (C) THAT THE SOFTWARE WILL NOT DAMAGE ANY OTHER SOFTWARE, HARDWARE OR DATA, (D) THAT ANY SOFTWARE, NETWORK SERVICES (INCLUDING THE INTERNET) OR PRODUCTS (OTHER THAN THE SOFTWARE) UPON WHICH THE SOFTWARE'S PERFORMANCE DEPENDS WILL CONTINUE TO BE AVAILABLE,

UNINTERRUPTED OR UNMODIFIED, AND (E) REGARDING THE USE OR THE RESULTS OF THE USE OF THE SOFTWARE IN TERMS OF ITS CORRECTNESS, ACCURACY, RELIABILITY, OR OTHERWISE.

NO ORAL OR WRITTEN INFORMATION OR ADVICE GIVEN BY SONY OR AN AUTHORIZED REPRESENTATIVE OF SONY SHALL CREATE A WARRANTY, DUTY OR CONDITION OR IN ANY WAY INCREASE THE SCOPE OF THIS WARRANTY. SHOULD THE SOFTWARE PROVE DEFECTIVE YOU ASSUME THE ENTIRE COST OF ALL NECESSARY SERVICING, REPAIR OR CORRECTION. SOME JURISDICTIONS DO NOT ALLOW THE EXCLUSION OF IMPLIED WARRANTIES, SO THESE EXCLUSIONS MAY NOT APPLY TO YOU.

LIMITATION OF LIABILITY

SONY AND EACH OF THE THIRD-PARTY SUPPLIERS (for purposes of this Section, SONY and each of the THIRD-PARTY SUPPLIERS shall be collectively referred to as "SONY") SHALL NOT BE LIABLE FOR ANY INCIDENTAL OR CONSEQUENTIAL DAMAGES FOR BREACH OF ANY EXPRESS OR IMPLIED WARRANTY, BREACH OF CONTRACT, NEGLIGENCE, STRICT LIABILITY OR UNDER ANY OTHER LEGAL THEORY RELATED TO THE SOFTWARE, INCLUDING, BUT NOT LIMITED TO, ANY DAMAGES ARISING OUT OF LOSS OF PROFITS, LOSS OF REVENUE, LOSS OF DATA, LOSS OF USE OF THE SOFTWARE OR ANY ASSOCIATED HARDWARE, DOWN TIME AND USER'S TIME, EVEN IF ANY OF THEM HAVE BEEN ADVISED OF THE POSSIBILITY OF SUCH DAMAGES. IN ANY CASE, EACH AND ALL OF THEIR AGGREGATE LIABILITY UNDER ANY PROVISION OF THIS EULA SHALL BE LIMITED TO THE AMOUNT ACTUALLY PAID FOR THE PRODUCT. SOME JURISDICTIONS DO NOT ALLOW THE EXCLUSION OR LIMITATION OF INCIDENTAL OR CONSEQUENTIAL

DAMAGES, SO THE ABOVE EXCLUSION OR LIMITATION MAY NOT APPLY TO YOU.

AUTOMATIC UPDATE FEATURE

From time to time, SONY or the THIRD-PARTY SUPPLIERS may automatically update or otherwise modify the SOFTWARE, including, but not limited to, for purposes of enhancement of security functions, error correction and improvement of functions, at such time as you interact with SONY's or third parties' servers, or otherwise. Such updates or modifications may delete or change the nature of features or other aspects of the SOFTWARE, including, but not limited to, functions you may rely upon. You acknowledge and agree that such activities may occur at SONY's sole discretion and that SONY may condition continued use of the SOFTWARE upon your complete installation or acceptance of such update or modifications. Any updates/modifications shall be deemed to be, and shall constitute part of, the SOFTWARE for purposes of this EULA. By acceptance of this EULA, you consent to such update/modification.

ENTIRE AGREEMENT, WAIVER, SEVERABILITY

This EULA and SONY's privacy policy, each as amended and modified from time to time, together constitute the entire agreement between you and SONY with respect to the SOFTWARE. The failure of SONY to exercise or enforce any right or provision of this EULA shall not constitute a waiver of such right or provision. If any part of this EULA is held invalid, illegal, or unenforceable, that provision shall be enforced to the maximum extent permissible so as to maintain the intent of this EULA, and the other parts will remain in full force and effect.

GOVERNING LAW AND JURISDICTION

The United Nations Convention on Contracts for the International Sale of Goods shall not apply to this EULA. This EULA shall be governed by the laws of Japan, without regards to conflict of laws provisions. Any dispute arising out of this EULA shall be subject to the exclusive venue of the Tokyo District Court in Japan, and the parties hereby consent to the venue and jurisdiction of such courts.

EQUITABLE REMEDIES

Notwithstanding anything contained in this EULA to the contrary, you acknowledge and agree that any violation of or non-compliance with this EULA by you will cause irreparable harm to SONY, for which monetary damages would be inadequate, and you consent to SONY obtaining any injunctive or equitable relief that SONY deems necessary or appropriate in such circumstances. SONY may also take any legal and technical remedies to prevent violation of and/or to enforce this EULA, including, but not limited to, immediate termination of your use of the SOFTWARE, if SONY believes in its sole discretion that you are violating or intend to violate this EULA. These remedies are in addition to any other remedies SONY may have at law, in equity or under contract.

TERMINATION

Without prejudice to any of its other rights, SONY may terminate this EULA if you fail to comply with any of its terms. In case of such termination, you must cease all use, and destroy any copies, of the SOFTWARE.

AMENDMENT

SONY RESERVES THE RIGHT TO AMEND ANY OF THE TERMS OF THIS EULA AT ITS

SOLE DISCRETION BY POSTING NOTICE ON A SONY DESIGNATED WEB SITE, BY EMAIL NOTIFICATION TO AN EMAIL ADDRESS PROVIDED BY YOU, BY PROVIDING NOTICE AS PART OF THE PROCESS IN WHICH YOU OBTAIN UPGRADES/UPDATES OR BY ANY OTHER LEGALLY RECOGNIZABLE FORM OF NOTICE. If you do not agree to the amendment, you should promptly contact SONY for instructions. Your continued use of the SOFTWARE after the effective date of any such notice shall be deemed your agreement to be bound by such amendment.

THIRD-PARTY BENEFICIARIES

Each THIRD-PARTY SUPPLIER is an express intended third-party beneficiary of, and shall have the right to enforce, each provision of this EULA with respect to the SOFTWARE of such party.

Should you have any questions concerning this EULA, you may contact SONY by writing to SONY at applicable contact address of each area or country.

Copyright © 2018 Sony Video & Sound Products Inc. All rights reserved.

Precautions

On safety

- Should any solid object or liquid fall into the system, unplug the system and have it checked by qualified personnel before operating it any further.
- Do not climb on the main unit and subwoofer, as you may fall down and injure yourself, or system damage may result.

On power sources

- Before operating the system, check that the operating voltage is identical to your local power supply. The operating voltage is indicated on the nameplate at the bottom of the main unit.
- If you are not going to use the system for a long time, be sure to disconnect the system from the wall outlet (mains). To disconnect the AC power cord (mains lead), grasp the plug itself; never pull the cord.
- One blade of the plug is wider than the other for the purpose of safety and will fit into the wall outlet (mains) only one way. If you are unable to insert the plug fully into the outlet, contact your dealer.
- AC power cord (mains lead) must be changed only at a qualified service shop.

On heat buildup

Although the system heats up during operation, this is not a malfunction. If you continuously use this system at high volume, the system temperature at the rear and bottom rises considerably. To avoid burning yourself, do not touch the system.

On placement

- Do not place the system near heat sources or in a place subject to direct sunlight, excessive dust, or mechanical shock.
- Do not place anything at the rear of the main unit and subwoofer that might block

the ventilation holes and cause malfunctions.

- Do not place metal objects other than a TV around the system. Wireless functions may be unstable.
- If the system is being used in combination with a TV, VCR, or tape deck, noise may result and picture quality may suffer. In such a case, place the system away from the TV, VCR, or tape deck.
- Use caution when placing the system on a surface that has been specially treated (with wax, oil, polish, etc.), as staining or discoloration of the surface may result.
- Take care to avoid any possible injury from the corners of the main unit and subwoofer.
- Keep 3 cm or more space under the main unit when you hang it on a wall.
- The speakers of this system are not of magnetically shielded type. Do not place magnetic cards on the system or near it.

On handling the subwoofer

Do not place your hand into the slit of the subwoofer when lifting it. The speaker driver may be damaged. When lifting it, hold the bottom of the subwoofer.

On operation

Before connecting other devices, be sure to turn off and unplug the system.

If you encounter color irregularity on a nearby TV screen

Color irregularities may be observed on certain types of TV sets.

If color irregularity is observed...

Turn off the TV set, then turn it on again after 15 to 30 minutes.

If color irregularity is observed again...

Place the system further away from the TV set.

On cleaning

Clean the system with a soft, dry cloth. Do not use any type of abrasive pad, scouring powder, or solvent such as alcohol or benzene.

If you have any question or problem concerning your system, please consult your nearest Sony dealer.

Copyrights and Trademarks

This system incorporates Dolby* Digital and the DTS** Digital Surround System.

* Manufactured under license from Dolby Laboratories. Dolby, Dolby Audio, Dolby Atmos, Dolby Vision, and the double-D symbol are trademarks of Dolby Laboratories.

**For DTS patents, see <http://patents.dts.com>. Manufactured under license from DTS, Inc. DTS, the Symbol, DTS and the Symbol together, DTS:X, and the DTS:X logo are registered trademarks and/or trademarks of DTS, Inc. in the United States and/or other countries.
© DTS, Inc. All Rights Reserved.

The BLUETOOTH® word mark and logos are registered trademarks owned by Bluetooth SIG, Inc. and any use of such marks by Sony Corporation is under license. Other trademarks and trade names are those of their respective owners.

The terms HDMI and HDMI High-Definition Multimedia Interface, and the HDMI Logo are trademarks or registered trademarks of HDMI Licensing Administrator, Inc. in the United States and other countries.

“BRAVIA” logo is a trademark of Sony Corporation.

“ClearAudio+” is a trademark of Sony Corporation.

WALKMAN® and WALKMAN® logo are registered trademarks of Sony Corporation.

“PlayStation” is a registered trademark or trademark of Sony Interactive Entertainment Inc.

MPEG Layer-3 audio coding technology and patents licensed from Fraunhofer IIS and Thomson.

Windows Media is either a registered trademark or trademark of Microsoft Corporation in the United States and/or other countries.

This product is protected by certain intellectual property rights of Microsoft Corporation. Use or distribution of such technology outside of this product is prohibited without a license from Microsoft or an authorized Microsoft subsidiary.

“DSEE” is a trademark of Sony Corporation.

“TRILUMINOS” and “TRILUMINOS” logo are a registered trademark of Sony Corporation.

All other trademarks are trademarks of their respective owners.

Index

A

Advanced Auto Volume 47
ARC (Audio Return Channel) 9, 41, 48
Audio DRC 47
Audio Settings 47
Auto Standby 49

B

Bluetooth Codec - AAC 48
Bluetooth Mode 48
Bluetooth Settings 48
Bluetooth Standby 44, 48
BT.2020 64

C

Control for HDMI 40, 47

D

Device Name Setting 49
DIMMER 44
DSEE 47

E

eARC (Enhanced Audio Return Channel) 9, 21, 41, 48

H

HDCP 2.2 64
HDMI Settings 47
HDMI Signal Format 21, 48, 63
HDR 64

I

IR-Repeater 49

M

Manual Speaker Settings 47
Multiplex broadcast sound 37

N

NIGHT 34

O

OSD Language 49

R

Remote control 11
Resetting 49, 57

S

Secure Link 47
Software License Information 49
Software Update 49
Software Version 49
Sound Effect 47
Sound Mode 33
Speaker Settings 47
Standby Linked to TV 47
Standby Through 41, 44, 48
Subwoofer 25, 35, 54
System Settings 49

T

TV Audio Input Mode 48

U

Update 49

V

VERTICAL S. 32
VOICE 34

Support pages

Find information on software updates:

www.sony.eu/support

Smartphone app

Support by Sony app - Find information and get notification about your product:



- News & Alerts
- Software updates
- Tutorials
- Tips & Tricks

<https://sony.net/SBS>

 DOLBY ATMOS®



HDMI

<http://www.sony.net/>



* 4 7 2 5 8 6 5 2 2 * (2)

©2018 Sony Corporation Printed in Malaysia

4-725-865-22(2)