



marantz®

CD Player
CD6006

You can print more than one page of a PDF onto a single sheet of paper.

Owner's Manual

[Front panel](#)[Display](#)[Rear panel](#)[Remote](#)[Index](#)

Accessories	4
Inserting the batteries	5
Operating range of the remote control unit	5
Features	6
High quality sound	6
High performance	6
Part names and functions	7
Front panel	7
Display	9
Rear panel	10
Remote control unit	11

Connections

Connecting to a stereo audio amplifier	18
Connecting to a device with digital audio input connectors	19
Connecting an iPod or USB memory device to the USB port	20
Connecting devices with remote control connectors	22
Connection	22
Setting	22
Connecting the timer device	23
Connecting the power cord	24

Playback

Basic operation	26
Turning the power on	26
Selecting the playback media mode	27
Switching the display's brightness	27
Playing CDs	28
Playing CDs	28
A-B repeat playback	30
Playing tracks in a specific order (Program playback)	30
Skipping tracks you don't want to hear (Delete program playback)	31
Rewinding tracks slightly to listen again (Quick replay)	32
Switching the display (CD-TEXT)	33
Playing DATA CDs (MP3, WMA and AAC files)	34
Playing files	35
Playing an iPod	37
Listening to music on an iPod	38
Setting operation mode ("On-Display" mode)	38
Playing a USB memory device	40
Playing files stored on USB memory devices	41



Settings

Menu map	43
Menu operation	44
H/P AMP GAIN	45
Digital Out	45
Timer Play	46
Resume Play	46
Quick Replay	47
Auto Standby	47

Tips

Tips	49
Troubleshooting	50

Appendix

Playable media	55
Discs	55
Files	55
USB memory device	56
Playback order of MP3/WMA/AAC/WAV files	58
About discs and files	58
Cautions on using media	59
Inserting a disc	59
How to handle media	60
Cleaning discs	60
Explanation of terms	61
Trademark information	62
Specifications	63
Index	66





Thank you for purchasing this Marantz product.

To ensure proper operation, please read this owner's manual carefully before using the product.

After reading this manual, be sure to keep it for future reference.

Accessories

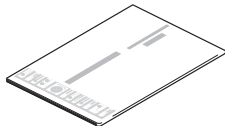
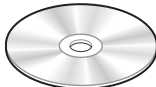
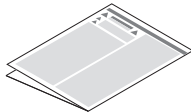
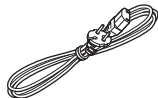
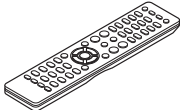
Check that the following parts are supplied with the product.

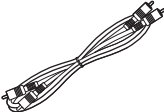
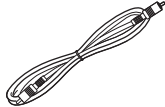
 Quick Start Guide	 CD-ROM (Owner's Manual)	 Safety Instructions	 Power cord
 Remote control unit (RC003PMCD)	 R03/AAA batteries	 Audio cable	 Remote connector cable



Inserting the batteries

- 1 Remove the rear lid in the direction of the arrow and remove it.



- 2 Insert two batteries correctly into the battery compartment as indicated.

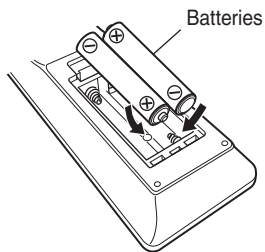

- 3 Put the rear cover back on.

NOTE

- To prevent damage or leakage of battery fluid:
 - Do not use a new battery together with an old one.
 - Do not use two different types of batteries.
- Remove the batteries from the remote control unit if it will not be in use for long periods.
- If the battery fluid should leak, carefully wipe the fluid off the inside of the battery compartment and insert new batteries.

Operating range of the remote control unit

Point the remote control unit at the remote sensor when operating it.

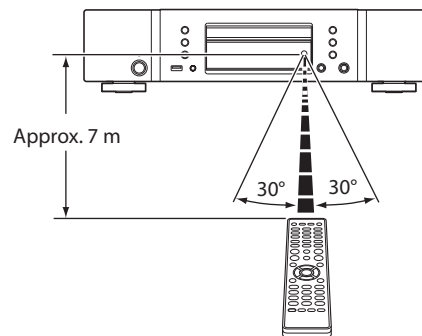

Features

High quality sound

- **Using Marantz original HDAM® SA2 circuit**

The unit uses an HDAM® SA2 circuit, whose quality has been proved in Super Audio CD players and high-end amplifiers, as a high-speed buffer amplifier.

You can enjoy the high speed and high-quality sound like that produced by high-end equipment.

- **Incorporates a Cirrus Logic advanced D/A converter, CS4398**

A D/A converter is an essential element for the audio quality of a CD player. The CS4398 Cirrus Logic D/A Converter, which has a reputation for high precision and has been adopted for other Marantz Super Audio CD players, is adopted for this unit.

- **High grade headphone circuit**

The high-grade headphone circuit incorporates a high-speed buffer amplifier to enable headphone listening of high quality sound reproduction, late at night or in other such situations.

High performance

- **Supports MP3, WMA and AAC file playback** (🔑 p. 34)

MP3, WMA and AAC files that have been recorded onto CD-R or CD-RW discs can be played back on this CD player.

- **Plays USB audio sources (MP3/WMA/AAC/WAV) and iPod**

This unit can play back MP3, WMA, WAV and AAC files by connecting an USB device or iPod to its USB port.

- **Gain selector function**

This unit has a gain control function with three levels that can be switched according to the characteristics of the connected headphones.

- **Quick replay function (Audio CDs only)** (🔑 p. 32)

Simply press the Q.REPLAY button on the remote control during playback, and the track rewinds the set amount of time (setting range: 5-60 seconds), and resumes playing from the rewind point.

- **Supports CD-TEXT display**

CD-Text is an extension to the existing audio CD standard that enables text information, such as the name of the artist, album title and song titles to be stored on an audio CD. CDs with the following logos support this function.



- **Large 16-character / 2-line display**

Text information appears on the large display during MP3 or iPod playback.



Part names and functions

Front panel

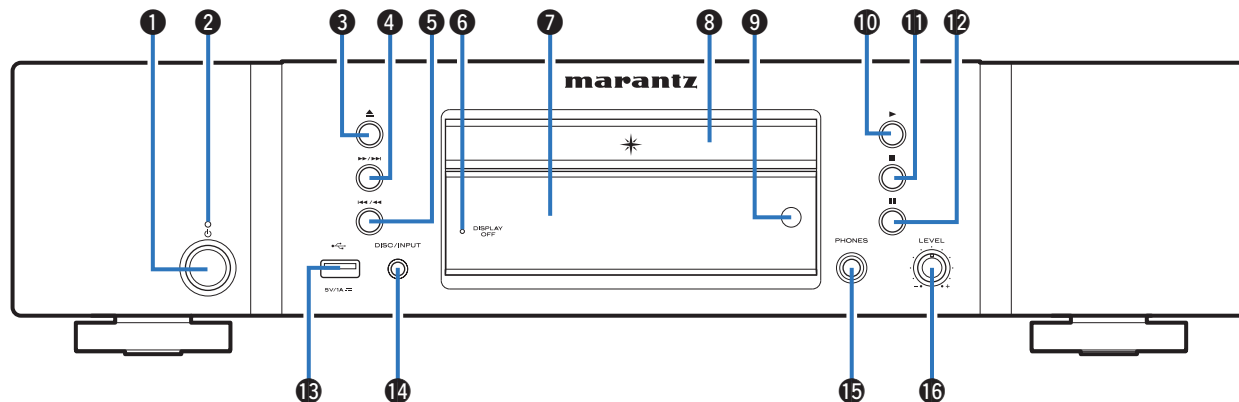

1 Power operation button (⏻)

This turns the power on/off (standby). (👉 p. 26)

2 Power indicator

This is lit as follows according to the power status:

- Power on : Off
- Standby : Red
- iPod charge standby : Orange

3 Disc tray open/close button (▲)

Opens and closes the disc tray. (👉 p. 28)

4 Fast-forward/Forward-skip button (▶▶▶▶)

Plays the next track. Press and hold to fast-forward the track.



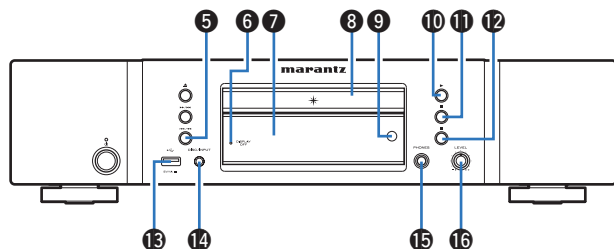

5 Fast-reverse/Reverse-skip button (⏮/⏪)

Returns to the start of the currently playing track. Press and hold to fast-reverse the track.

6 DISPLAY OFF indicator

Lights when the display is off. (👉 p. 27)

7 Display

This displays various pieces of information. (👉 p. 9)

8 Disc tray

Used to insert a disc. (👉 p. 28)

9 Remote control sensor

This receives signals from the remote control unit. (👉 p. 5)

10 Play button (▶)

Playback starts.

11 Stop button (■)

Stops playback.

12 Pause button (⏸)

Pauses playback.

13 USB port

Used to connect USB storages (such as USB memory devices) and the USB cable supplied with iPod. (👉 p. 20)

14 DISC/INPUT button

Used to select the playback source. (👉 p. 27)

15 Headphones jack (PHONES)

Used to connect headphones.

NOTE

- To prevent hearing loss, do not raise the volume level excessively when using headphones.

16 Headphone volume control knob (LEVEL)

Adjusts the headphone volume.



Display

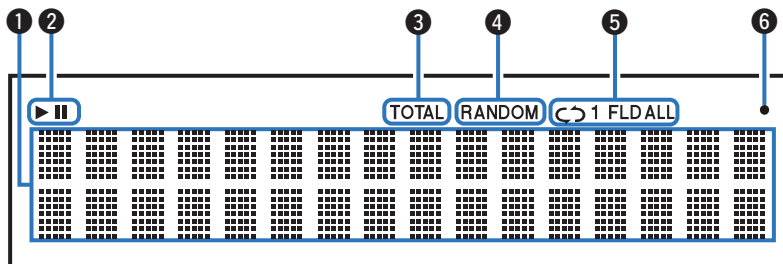

1 Information display

Displays various information or playback elapsed time and so on of the disc.

2 Playback mode indicators

▶ : Lights up during playback.

|| : Lights up during pause.

3 TOTAL indicator

Lights when the total number of tracks and total time of the CD are displayed.

4 RANDOM indicator

Lights during random playback.

5 Repeat mode indicators

Lights to match the repeat mode settings.

6 Remote control signal reception indicator

Lights when a signal is received from the remote control.



Rear panel

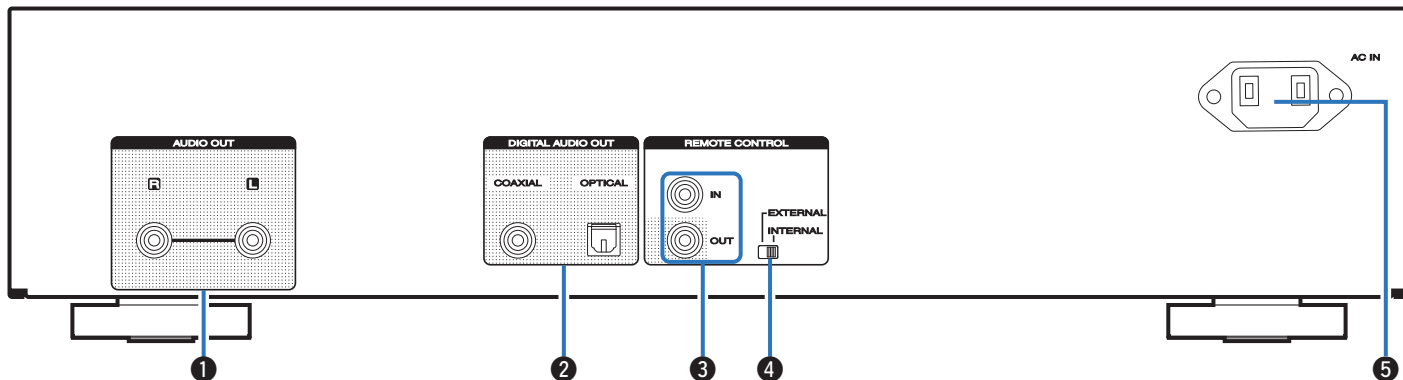

1 AUDIO OUT connectors

Used to connect devices equipped with analog audio inputs connectors or an external power amplifier. (☞ p. 18)

2 DIGITAL AUDIO OUT connectors (COAXIAL/OPTICAL)

Used to connect an AV receiver or D/A converter that has a digital input connectors. (☞ p. 19)

3 REMOTE CONTROL jacks

Used to connect to a Marantz amplifier that is compatible with the remote control function. (☞ p. 22)

4 EXTERNAL/INTERNAL switch

Turn this switch to “EXTERNAL” to operate the unit by pointing the remote control at the amplifier connected to this unit using the remote control connection. (☞ p. 22)

5 AC inlet (AC IN)

Used to connect the power cord. (☞ p. 24)



Remote control unit

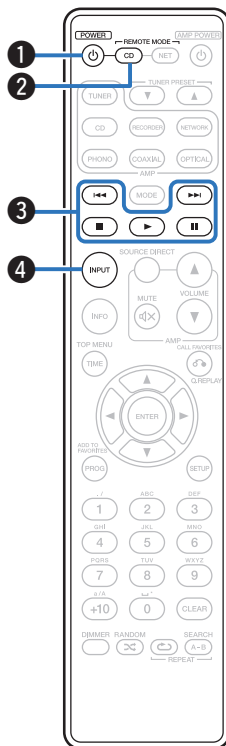

■ Operating this unit

To operate CD player, press REMOTE MODE CD button to switch the remote control to the CD operation mode.

- REMOTE MODE CD button lights for approximately two seconds.

1 Power operation button (POWER ϕ)

This turns the power on/off (standby). (☞ p. 26)

2 Remote mode select button (REMOTE MODE CD)

This switches the remote control operating mode to CD.

3 System buttons

These perform playback related operations.

- Skip buttons (⏮ / ⏭)
- Stop button (■)
- Play button (▶)
- Pause button (⏸)

4 Media mode select button (INPUT)

Used to select the playback source. (☞ p. 27)



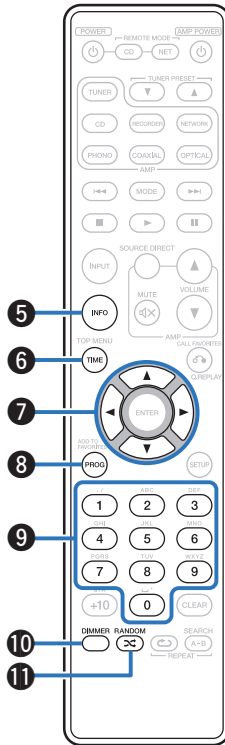

5 Information button (INFO)

This switches the track information shown in the display during playback.

6 TIME button

This switches the playback time display.

7 Cursor buttons (Δ∇◀▶)

These select items.

8 Program button (PROG)

This sets program playback. (🔗 p. 30)

9 Number buttons (0 – 9)

These enter letters or numbers into the unit.

10 DIMMER button

This switches the brightness of the display. (🔗 p. 27)

11 RANDOM button (🎲)

Switches the random playback.



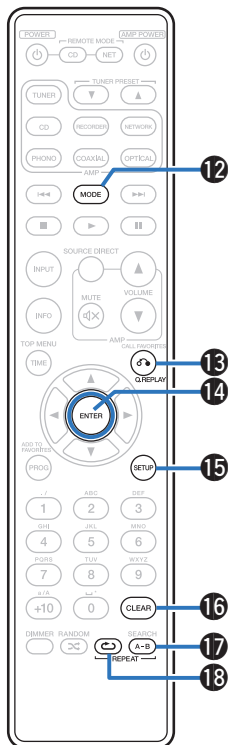

12 Playback mode switching button (MODE)

This switches the playback mode.

13 Q.REPLAY button

Rewinding tracks slightly to listen again. (☞ p. 32)

14 ENTER button

This determines the selection.

15 SETUP button

This displays the setting menu on the display. (☞ p. 44)

16 CLEAR button

This clears the program registration. (☞ p. 31)

17 REPEAT A-B button

This sets A-B repeat playback. (☞ p. 30)

18 REPEAT button (↺)

Switches the repeat playback.



- The amp and tuner can be operated with the amp operation buttons even when the remote control mode is CD.



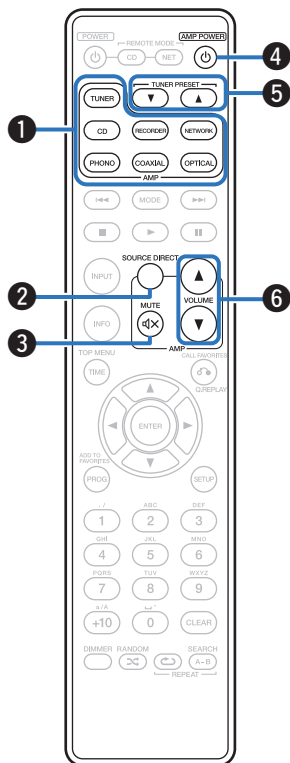

■ Amplifier and Tuner operations

A Marantz amplifier and tuner can be operated.

- ① Input source select buttons
- ② SOURCE DIRECT button
- ③ MUTE button (M)
- ④ AMP POWER button (P)
- ⑤ TUNER PRESET buttons (▲▼)
- ⑥ VOLUME buttons (▲▼)



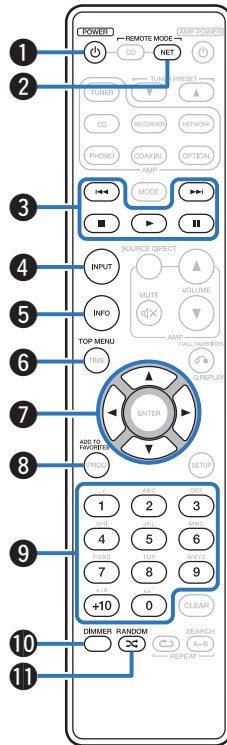

■ Network audio player operations

To operate a Marantz network audio player, press the REMOTE MODE NET button to switch the remote control to the network audio player operation mode.

- REMOTE MODE NET button lights for approximately two seconds.

1 POWER button (⏻)

2 Remote mode select button (REMOTE MODE NET)

3 System buttons

- Skip buttons (⏮ / ⏭)
- Stop button (⏸)
- Play button (▶)
- Pause button (⏸)

4 Media mode select button (INPUT)

5 Information button (INFO)

6 TOP MENU button

7 Cursor buttons (⬆ / ⬇ / ⬅ / ➡)

8 ADD TO FAVORITES button

9 Number buttons (0 – 9, +10)

10 DIMMER button

11 RANDOM button (⚡)



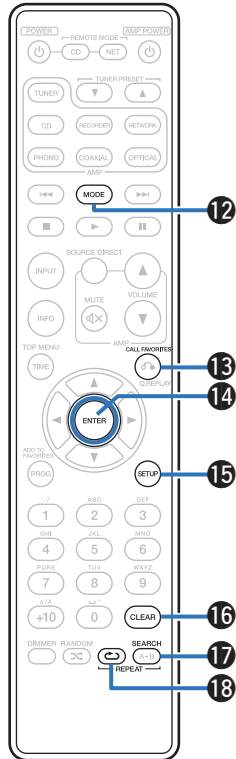

- 12 MODE button
- 13 CALL FAVORITES button
- 14 ENTER button
- 15 SETUP button
- 16 CLEAR button
- 17 SEARCH button
- 18 REPEAT button (↺)



- The amp and tuner can be operated with the amp operation buttons even when the remote control mode is "NET".
- When using it, also refer to the operating instructions of the other devices.



■ Contents





Connecting to a stereo audio amplifier	18
Connecting to a device with digital audio input connectors	19
Connecting an iPod or USB memory device to the USB port	20
Connecting devices with remote control connectors	22
Connecting the timer device	23
Connecting the power cord	24

NOTE

- Do not plug in the power cord until all connections have been completed.
- Do not bundle power cords together with connection cables. Doing so can result in noise.

■ Cables used for connections

Provide necessary cables according to the devices you want to connect.

Audio cable (supplied)	
Remote connector cable (supplied)	
Optical cable (Sold separately)	
Coaxial digital cable (Sold separately)	



Connecting to a stereo audio amplifier

Use this connection for audio playback via an amplifier.

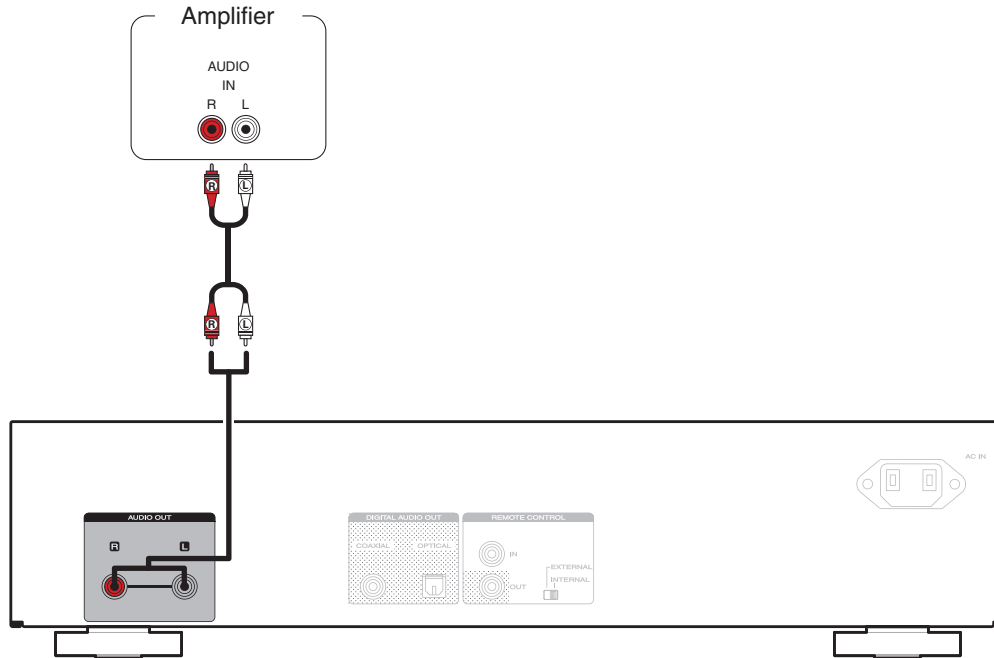

Connecting to a device with digital audio input connectors

You can enjoy digital audio playback by connecting an AV receiver or D/A converter that has a digital audio terminal to this unit.

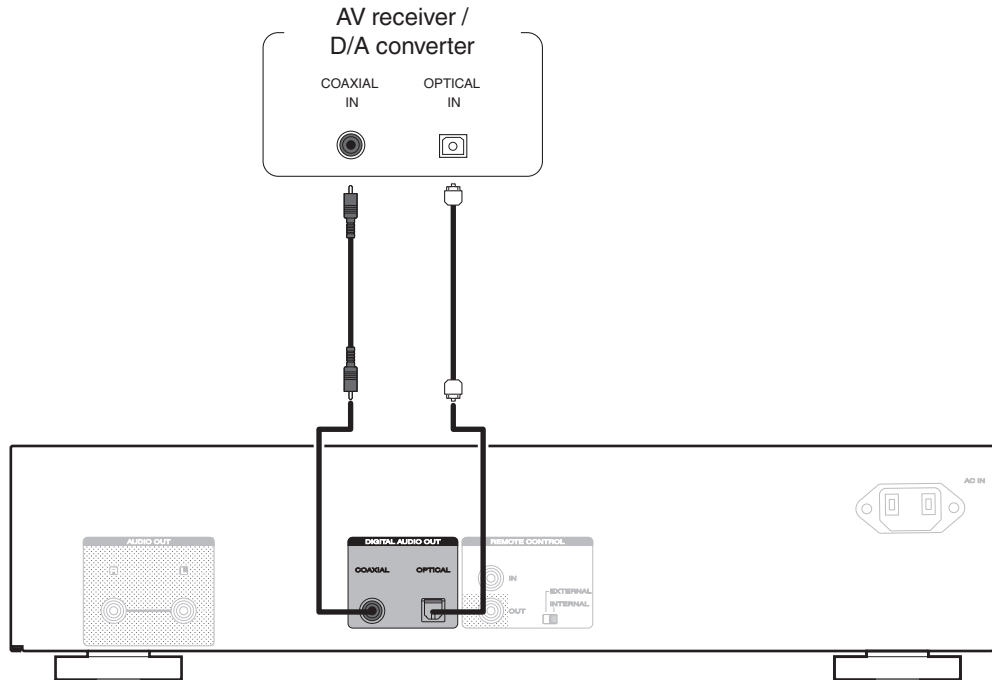

Connecting an iPod or USB memory device to the USB port

You can enjoy music stored on an iPod/iPhone or USB memory device.

- To connect an iPod/iPhone to this unit, use the USB adapter cable that was supplied with the iPod/iPhone.
- For operating instructions, see “Playing an iPod” (🔍 p. 37) or “Playing a USB memory device” (🔍 p. 40).

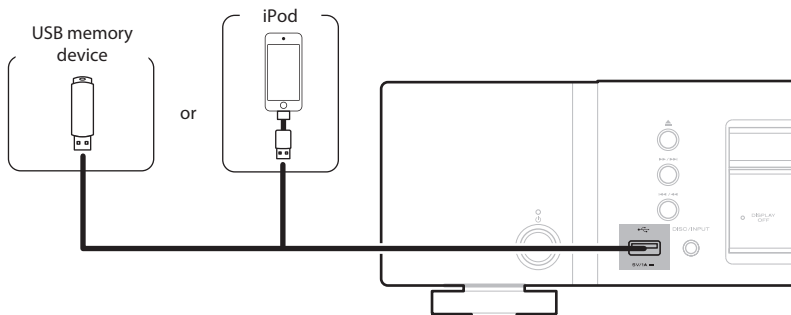

- Marantz does not guarantee that all USB memory devices will operate or receive power. When using a portable USB hard disk drive (HDD) which came with an AC adapter, use that device's supplied AC adapter.

NOTE

- USB memory devices will not work via a USB hub.
- It is not possible to use this unit by connecting the unit's USB port to a PC via a USB cable.
- Do not use an extension cable when connecting a USB memory device. This may cause radio interference with other devices.



■ Supported iPod/iPhone models

• iPod classic



iPod classic
80GB



iPod classic
160GB (2007)



iPod classic
160GB (2009)

• iPod nano



iPod nano
3rd generation
(video)
4GB 8GB



iPod nano
4th generation (video)
8GB 16GB



iPod nano
5th generation (video camera)
8GB 16GB



iPod nano
6th generation
8GB 16GB



iPod nano
7th generation
16GB

• iPod touch



iPod touch
1st generation
8GB 16GB 32GB



iPod touch
2nd generation
8GB 16GB 32GB



iPod touch
3rd generation
32GB 64GB



iPod touch
4th generation
8GB 32GB 64GB



iPod touch
5th generation
32GB 64GB

• iPhone



iPhone
4GB 8GB 16GB



iPhone 3G
8GB 16GB



iPhone 3GS
8GB 16GB 32GB



iPhone 4
8GB 16GB 32GB



iPhone 4S
16GB 32GB 64GB



iPhone 5
16GB 32GB 64GB



Connecting devices with remote control connectors

When you use this unit connected to a Marantz amplifier, this unit receives operation signals sent from the amplifier and operates accordingly. Next, configure the “Connection” and “Setting”.

Connection

Use the supplied remote connector cable to connect the REMOTE CONTROL IN connector of this unit to REMOTE CONTROL OUT connector of the amplifier.

Setting

Turn the EXTERNAL/INTERNAL switch on the unit to “EXTERNAL”.

- This setting will disable remote sensor reception of this unit.
- To operate the unit, point the remote control at the remote sensor of the amplifier.



- To use this unit by itself without connecting an amplifier, turn the switch to “INTERNAL”.

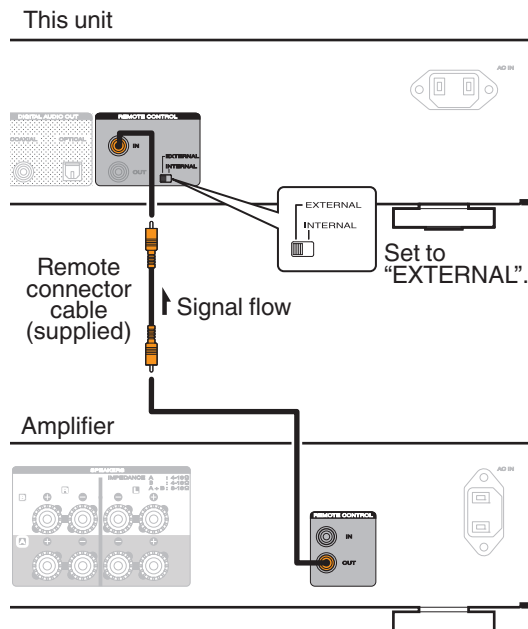

Connecting the timer device

This unit can perform timer play when an amplifier and timer device are connected to this unit.
("Timer Play" (p. 46))

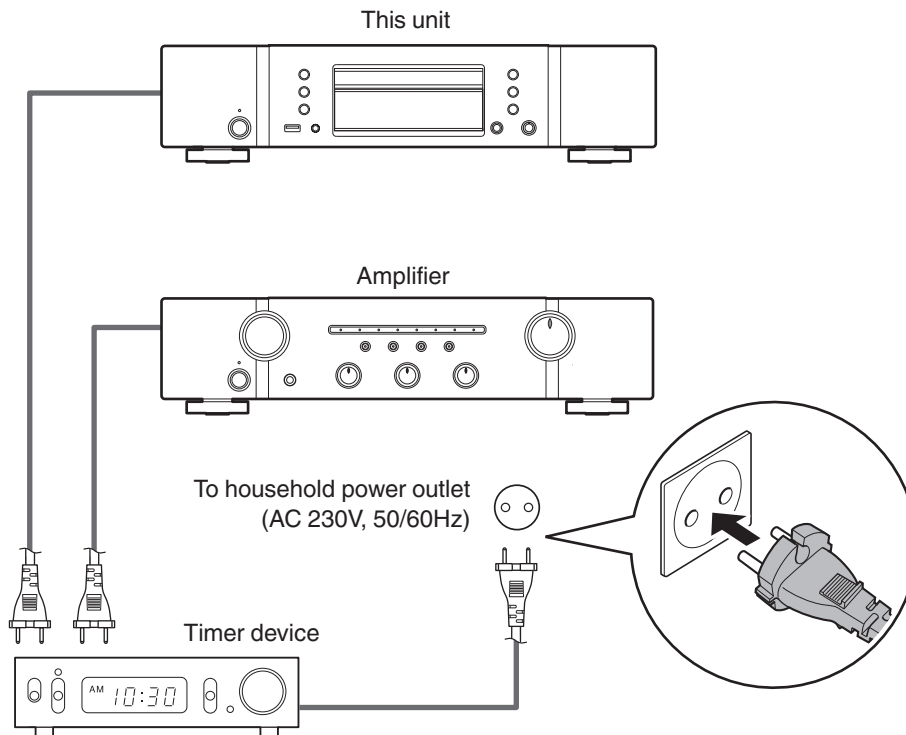

Connecting the power cord

After completing all the connections, insert the power plug into the power outlet.

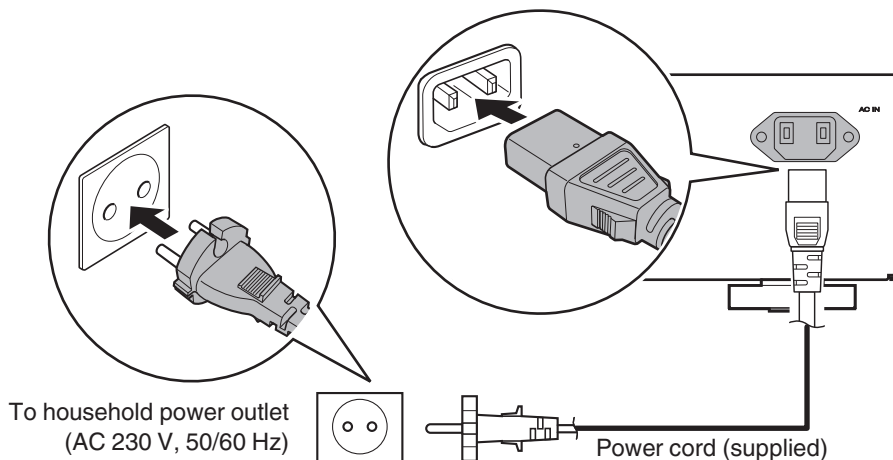

■ Contents

Basic operation	26
Playing CDs	28
Playing DATA CDs (MP3, WMA and AAC files)	34
Playing an iPod	37
Playing a USB memory device	40



Basic operation

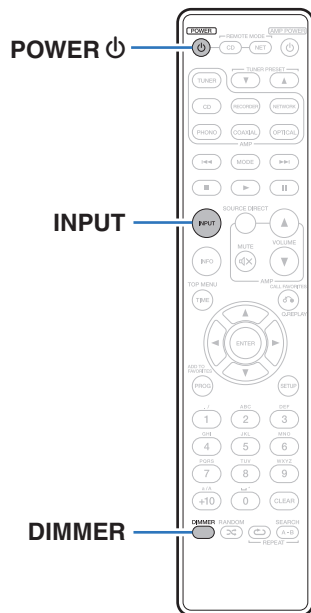

Turning the power on

- 1 Press **POWER** to turn on power to the unit.
The power indicator turns off.



- You can also press on the main unit to turn the power on.

■ When power is switched to standby

- 1 Press **POWER** .
- The unit switches to standby mode, and the Power indicator lights red.

NOTE

- Power continues to be supplied to some of the circuitry even when the power is in the standby mode. When leaving home for long periods of time or when going on vacation, unplug the power cord from the power outlet.



Selecting the playback media mode

1 Press INPUT to select the playback media mode.

Disc (Default) :	Select to playback a disc.
USB:	Select to playback a iPod and USB memory device.



- You can also select the playback media mode by pressing DISC/INPUT on the unit.

Switching the display's brightness

The brightness of the display can be adjusted to one of four levels.

1 Press DIMMER.



Playing CDs

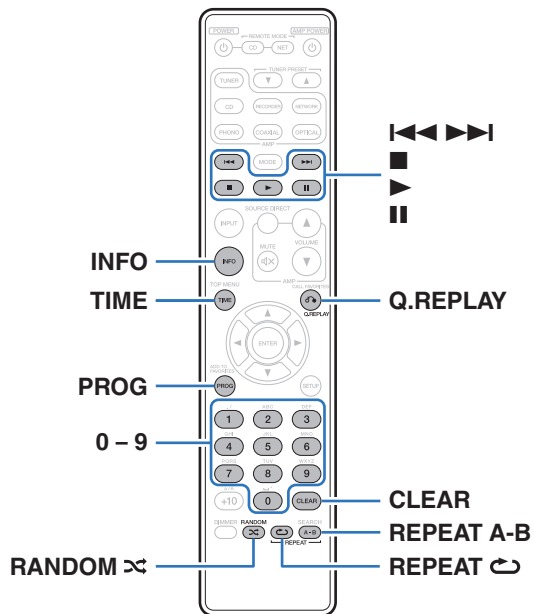

Playing CDs

1 Insert a disc. (p. 59)

- Press on the unit to open/close the disc tray.









2 Press .

The indicator lights on the display. Playback starts.

NOTE

- Do not place any foreign objects in the disc tray. Doing so could damage the set.
- Do not push the disc tray in by hand when the power is turned off. Doing so could damage the set.



Operation buttons	Function
	Playback
	Pause
	Stop
	Skip to previous track / Skip to next track (Press and hold) Fast-reverse / Fast-forward
0 - 9	Select the track
RANDOM 	Random playback
REPEAT 	Repeat playback <ul style="list-style-type: none"> Switching between All-track repeat and Single-track repeat.
REPEAT A-B	A-B repeat playback ( p. 30)
TIME	Time display switching <ul style="list-style-type: none"> Track elapsed time, Track remaining time and Total remaining time
Q.REPLAY	Rewinding tracks slightly to listen again. ( p. 32)

■ Playing a specific track (Direct searching)

1 Use 0 - 9 to select the tracks.

[Example]

Track 4 :

Press number 4 to select track 4.

Track 12 :

Press numbers 1 and 2 consecutively to select track 12.



- The number you enter is set about 1.5 seconds after you press the number buttons. To enter a two-digit number, be sure to press the two number buttons, one immediately after the other.



A-B repeat playback

You can specify the section within a track that you want to hear, and play it back repeatedly.

- 1 During playback, press REPEAT A-B at the point where you want to start playing repeatedly.**
“Repeat A-” is displayed on the display.
- 2 Press REPEAT A-B at the point where you want to stop playing repeatedly.**
“Repeat A-B” is displayed on the display, and the specified section (point A to point B) is played back repeatedly.

■ To cancel A-B repeat playback

Press REPEAT A-B.





- A-B repeat playback cannot be used during random playback.

Playing tracks in a specific order (Program playback)

Up to 25 tracks can be programmed.

- 1 In the stop mode, press PROG.**
“Program” is displayed on the display.
- 2 Use 0 – 9 to select the tracks.**
[Example]
Track 4 : Press number 4 to select track 4.
Track 12 : Press numbers 1 and 2 consecutively to select track 12.
 - The number you enter is set about 1.5 seconds after you press the number buttons. To enter a two-digit number, be sure to press the two number buttons, one immediately after the other.
- 3 Press ►.**
Playback starts in the programmed order.



- When RANDOM  is pressed during program playback, the programmed tracks are played in random order.
- When REPEAT  is pressed during program playback, the tracks are played repeatedly in the programmed order.

NOTE

- The program is cleared when the disc tray is opened or the power is turned off.



■ Checking the order of the programmed tracks

In the stop mode, press ►►I.

The tracks are shown in the programmed order in the display each time ►►I is pressed.

■ To clear the last track programmed

In the stop mode, press CLEAR.

The last track programmed is cleared each time the button is pressed.

■ Clearing the all programmed track

In the stop mode, press PROG.

Skipping tracks you don't want to hear (Delete program playback)

A maximum of 25 tracks can be programmed for delete program playback.

1 During stop mode, press PROG, and then press CLEAR.

“Delete Program” is displayed on the display.

2 Use 0 – 9 to select the tracks you want to skip.

[Example]

If you want to skip the 3rd and 12th tracks, press 3 and then press 1 and 2.

3 Press ►.

Playback starts, and the selected tracks are skipped.

■ Checking details of the delete program

In the stop mode, press ►►I.

The skipped tracks are shown in order in the display each time ►►I is pressed.



■ To clear the last delete program track

In the stop mode, press CLEAR.

The last track set in the delete program is cleared in order each time CLEAR is pressed.

■ Clearing the all delete program tracks

In the stop mode, press PROG.

Rewinding tracks slightly to listen again (Quick replay)

Simply press Q.REPLAY during playback to rewind the track the amount of time set in the menu and playback again. (Default setting : 10 sec)

For details on the settings, see “Quick Replay” (🔍 p. 47).

NOTE

- The quick replay function is enabled only during CD playback.
- Quick replay cannot be used between different tracks. Also, if the overall time of the track being played back is shorter than the quick play setting time, or if the playback time is shorter than the quick play setting time, when Q.REPLAY is pressed the track is played back from the start.



Switching the display (CD-TEXT)

- You can view text information stored on a disc as CD-TEXT on this unit. Mainly, information on the current track being played is displayed.
- A maximum of 32 characters can be displayed.

1 During playback, press INFO.

Switching between the title name, artist name and album name.



- You can set which information is displayed first when INFO is pressed.
- The player can display the following characters:

ABCDEFGHIJKLMNOPQRSTUVWXYZ

abcdefghijklmnopqrstuvwxyz

0123456789

!"#\$%& :;<>?@\[_`!{ }~^'()*+,-./=(space)

- A period (".") is displayed instead of any character that cannot be displayed by the player.

NOTE

- As the stored information differs depending on the disc, all of the information may not be displayed.



Playing DATA CDs (MP3, WMA and AAC files)

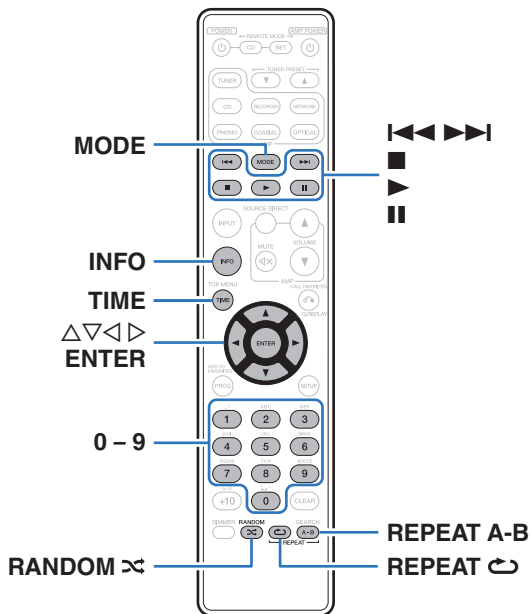

- This section explains how to playback MP3, WMA and AAC files that are recorded onto a CD-R or CD-RW. For details on how to playback files recorded onto media other than CD-R or CD-RW, see the following sections.
- There are many music distribution sites on the Internet allowing you to download music files in MP3 or WMA (Windows Media® Audio) format. The music (files) downloaded from such sites can be stored on CD-R or CD-RW discs and played on this unit.

“Windows Media” and “Windows” are the trademarks or registered trademarks of Microsoft Corporation in the United States and other countries.



Playing files

1 Load a CD-R or CD-RW disc containing music files in the MP3, WMA or AAC formats into the disc tray.

( p. 59)

- Press  on the unit to open/close the disc tray.

2 Press MODE to select “Folder” or “All”.

About the display

- **When “Folder” is selected**

“FLD” indicator lights.

All the files in the selected folder are played.

- **When “All” is selected**

“FLD” indicator turns off.









After the selected folder and files are played, all the files in all the folders are played.

3 Use to select the folder to be played.

4 Use to select the file to be played.

5 Press .

Playback starts.

Operation buttons	Function
	Playback
	Pause
	Stop
	Skip to previous track / Skip to next track (Press and hold) Fast-reverse / Fast-forward
	Folder select
	File select
0 – 9	Select the track
MODE	Select the playback range
RANDOM 	Random playback
REPEAT 	Repeat playback <ul style="list-style-type: none"> • Switching between All-track repeat and Single-track repeat.
REPEAT A-B	A-B repeat playback ( p. 30)
TIME	Time display switching <ul style="list-style-type: none"> • Display switches between the track elapsed time and total remaining time.



- The folder and file numbers are set automatically when the disc is loaded.



NOTE

- Programmed playback is not possible with MP3/WMA/AAC discs.
- Copyright-protected files cannot be played.
(The “Not Support” is displayed.)
Note that depending on the software used for burning and other conditions, some files may not play or display correctly.

■ Playable files (Extension) p. 55

■ To switch the folder or file during playback

- Folder
Use $\Delta \nabla$ to select the folder, then press ENTER.
- Files
Use $\triangleleft \triangleright$ to select the file, then press ENTER.
Also use $\blacktriangleleft \blacktriangleright$ to select the file, or use 0 – 9 to select the file number.
- The file numbers are set automatically when the disc is loaded.

■ Switching the display

During playback, press INFO.

- Switching between the file name, title name, artist name and album name.
- The player can display the following characters:

ABCDEFGHIJKLMNOPQRSTUVWXYZ

abcdefghijklmnopqrstuvwxyz

0123456789

!"#\$%&:;<>?@[]_`!{|}~^'()*+,-./=(space)

- A period (“.”) is displayed instead of any character that cannot be displayed by the player.



Playing an iPod

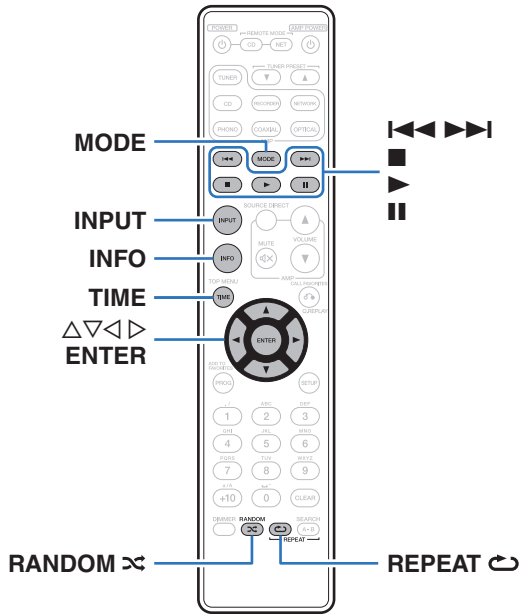

- You can use the USB cable provided with the iPod to connect the iPod with the unit's USB port and enjoy music stored on the iPod.
- For information on the iPod models that can be played back with this unit, see "Supported iPod/iPhone models" (👉 p. 21).



Listening to music on an iPod

- 1 **Connect the iPod to the USB port.** (🔗 p. 20)
- 2 **Press INPUT to select the playback media mode to “USB”.**
“From iPod” is displayed on the display of this unit.
- 3 **Operate iPod itself directly while seeing the iPod screen to play back music.**



- The iPod display modes include “From iPod” and “On-Display”. By default, “From iPod”, where you directly operate the iPod itself while looking at the iPod screen, is set.

NOTE

- Depending on the type of iPod and the software version, some functions may not operate.
- Note that Marantz will accept no responsibility whatsoever for any problems arising with the data on an iPod when using this unit in conjunction with the iPod.

Setting operation mode (“On-Display” mode)

In this mode, various lists and screens during playback on the iPod are displayed on the body.

This section describes the steps up to playing back tracks on the iPod in “On-Display”.







- 1 **Press MODE.**
“On-Display” is displayed on the display of this unit.
- 2 **Use Δ / ∇ to select the file to be played, then press ENTER.**

Playback starts.

Operation mode		From iPod	On-Display
Playable files	Music file	✓	✓
	Video file	*	
Active buttons	Remote control unit (This unit)	✓	✓
	iPod	✓	

* Only the sound is played.



Operation buttons	Function
	Playback
	Pause
	Stop
	Skip to previous track / Skip to next track (Press and hold) Fast-reverse / Fast-forward
RANDOM 	Random playback
REPEAT 	Repeat playback <ul style="list-style-type: none"> Switching between Single-track repeat and All-track repeat.
MODE	Setting iPod operation mode <ul style="list-style-type: none"> Switching between “From iPod” or “On-Display” mode.
	Select the item
TIME	Time display switching <ul style="list-style-type: none"> Display switches between the track elapsed time and track remaining time.
INFO	Text information display (“On-Display” mode only) <ul style="list-style-type: none"> Text information recorded on the media is displayed.

■ Switching the display

During playback, press INFO.

- This switches between the title name, artist name and album name.
- The player can display the following characters:

ABCDEFGHIJKLMNOPQRSTUVWXYZ

abcdefghijklmnopqrstuvwxyz

0123456789

!"#\$%&:;<>?@[]_`{|}~^'()*+,-./= (space)

- A period (“.”) is displayed instead of any character that cannot be displayed by the player.



Playing a USB memory device

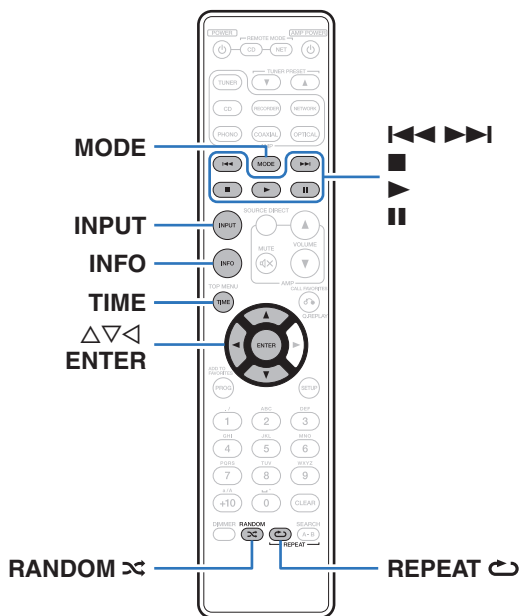









- Playing back music stored on a USB memory device.
- Only USB memory devices conforming to mass storage class standards can be played on this unit.
- This unit is compatible with USB memory devices in “FAT16” or “FAT32” format.
- This unit can play back the following files.
 - **WMA**
 - **MP3**
 - **WAV**
 - **AAC**



Playing files stored on USB memory devices

- 1 **Connect the USB memory device to the USB port.**
( p. 20)
- 2 **Press INPUT to select the playback media mode to “USB”.**
- 3 **Press MODE to select “Folder” or “All”.**
 - **About the display**
 - **When “Folder” is selected**
“FLD” indicator lights.
All the files in the selected folder are played.
 - **When “All” is selected**
“FLD” indicator turns off.
After the selected folder and files are played, all the files in all the folders are played.
- 4 **Use $\Delta \nabla$ to select the folder, then press ENTER.**
- 5 **Use $\Delta \nabla$ to select the file, then press ENTER.**
Playback starts.

Operation buttons	Function
	Playback
	Pause
	Stop
	Skip to previous track / Skip to next track
	(Press and hold) Fast-reverse / Fast-forward
	Moving up a level in the folder tree
	Select the item
ENTER	Enter the selected item / Playback
REPEAT 	Repeat playback <ul style="list-style-type: none"> • Switching between All-track repeat and Single-track repeat.
RANDOM 	Random playback
MODE	Switch to Folder playback mode <ul style="list-style-type: none"> • Switching between “Folder” or “All” mode.
TIME	Time display switching <ul style="list-style-type: none"> • Display switches between the track elapsed time and track remaining time.
INFO	Text information display <ul style="list-style-type: none"> • Text information recorded on the media is displayed.





- When the menu's "Resume Play" (🔊 p. 46) is on, playback starts automatically when a USB memory device is connected.
- When a USB memory device is connected to this unit, playback starts automatically when "USB" playback media mode switching occurs.

NOTE

- To play another file while playing from a USB memory device, press < to display the folder tree, Δ∇ to select the file to be played, and then press ENTER.
- Do not remove the USB memory device from the unit when the USB memory communication indicator is flashing. Doing so may damage the USB memory device, or may corrupt the files recorded on the USB memory device.
- Note that Marantz will accept no responsibility whatsoever for any problems arising with the data on a USB memory device when using this unit in conjunction with the USB memory device.

■ Files that can be played back

See "USB memory device" (🔊 p. 56).

■ Switching the display

During playback, press INFO.

- This switches between the file name, title name, artist name and album name.
- While a WAV file is being played back, only the file name is displayed.
- The player can display the following characters:

ABCDEFGHIJKLMNOPQRSTUVWXYZ

abcdefghijklmnopqrstuvwxyz

0123456789

!"#\$%&:;<>?@[]_`{|}~^`()*+,-./=(space)

- A period (".") is displayed instead of any character that cannot be displayed by the player.



Menu map

By default, this unit has recommended settings defined. You can customize this unit based on your existing system and your preferences.

Setting items	Description	Page
H/P AMP Gain	Set the gain of the headphone amplifier.	45
Digital Out	Switched the digital audio output on/off.	45
Timer Play	This unit can perform timer play by cooperating with your timer device.	46
Resume Play	When the media mode is switched, the iPod or USB memory device is disconnected and then connected, or the power is turned off and then back on during iPod or USB memory device playback, the unit memorizes the point where playback stopped so that playback can resume from after that point.	46
Quick Replay	You can set how many seconds a track is rewound when Q.REPLAY is pressed.	47
Auto Standby	Sets whether to automatically switch the unit to the standby mode when the unit remains in the stop mode for more than 30 minutes.	47



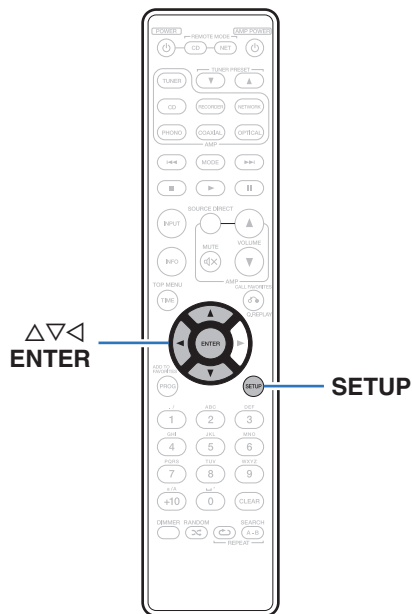

Menu operation

- 1 Press SETUP while playback is stopped.**
The menu is displayed on the display.
- 2 Use Δ / ∇ to select the menu to be set or operated, then press ENTER.**
- 3 Use Δ / ∇ to change to desired setting.**
- 4 Press ENTER to enter the setting.**
 - To return to the previous item, press \triangleleft .
 - Exiting the Menu, press SETUP while the menu is displayed. The display returns to the normal display.



H/P AMP GAIN

Set the gain of the headphone amplifier. Set this according to the impedance of the connected headphones. It is recommended that this is set on the "LOW" side if the headphones have low impedance and on the "HIGH" side if they have high impedance.

LOW (Default):	Set the gain of the headphone amplifier to "LOW".
MIDDLE:	Set the gain of the headphone amplifier to "MIDDLE".
HIGH:	Set the gain of the headphone amplifier to "HIGH".

NOTE

- The headphone volume varies depending on the "H/P AMP GAIN" setting. Decrease the volume or mute the audio first if changing this setting while listening to audio.

Digital Out

Switched the digital audio output on/off.

On (Default):	Use the digital audio output connector.
Off:	Do not use the digital audio output connector.



Timer Play

This unit can perform timer play by cooperating with your timer device.
 (“Connecting the timer device” (🔗 p. 23))

On: Timer play is set. Select the media mode to be used for timer play.

Off
 (Default): Timer play is not set.

■ Using the timer play function

1. Turn on the power of the connected components.
2. Load a disc or connect an iPod or USB memory device.
3. Switch the amplifier's function to input from the connected unit.
4. Set the audio timer for the desired times.
5. Turn the timer on.

The power of the components connected to the timer turns off.

When the set time is reached, the power of the different components automatically turns on and playback starts from the first track.

NOTE

- The timer play does not support the random play or program play.

Resume Play

When the media mode is switched, the iPod or USB memory device is disconnected and then connected, or the power is turned off and then back on during iPod or USB memory device playback, the unit memorizes the point where playback stopped (resume information) so that playback can resume from after that point.

On
 (Default): Resume playback is set.

Off: Resume playback is not set.

NOTE

- If a different USB memory device is connected, the resume information of the previously connected USB memory device is cleared.



Quick Replay

You can set how many seconds a track is rewound when Q.REPLAY is pressed.

5 – 60 seconds

(Default : 10 seconds)

Auto Standby

Sets whether to automatically switch the unit to the standby mode when the unit remains in the stop mode for more than 30 minutes.

On
(Default): Enable Auto Standby mode.

Off: Disable Auto Standby mode.



- When an iPod is being charged, this unit enters the power standby mode after charging is complete.

NOTE

- If an iPod is connected with this unit in the "From iPod" mode, this unit will not enter the standby mode, even after about 30 continuous minutes of stop mode with no operation.



■ Contents

Tips

I want to display CD-TEXT	49
I want to skip tracks on a CD	49
I want to repeatedly listen to a specific section	49
I want to playback just the specified folder	49
I want to stop the iPod or USB memory device from automatically starting playback	49
I want to display the title, etc. of the file currently playing back on the iPod on this unit's display	49
I want to playback WAV files	49
I want to use this unit's remote control to operate a Marantz network audio player	49

Troubleshooting

Power does not turn on / Power is turned off	50
Operations cannot be performed through the remote control unit	51
Display on this unit shows nothing	51
No sound comes out	52
Sound is interrupted or noise occurs	52
Desired sound does not come out	52
Cannot playback discs	53
iPod cannot be played back	53
USB memory devices cannot be played back	54
File names on the iPod/USB memory device are not displayed properly	54



Tips

I want to display CD-TEXT

- This unit is compatible with CD-TEXT. Press the INFO button to switch the displayed information. (👉 p. 33)

I want to skip tracks on a CD

- Select the tracks that you want to skip in delete program playback mode. (👉 p. 31)

I want to repeatedly listen to a specific section

- Set A-B repeat playback. (👉 p. 30)

I want to playback just the specified folder

- The MODE button to set the playback range to "Folder". (👉 p. 41)

I want to stop the iPod or USB memory device from automatically starting playback

- Set "Resume Play" to "Off" in the menu. (👉 p. 46)

I want to display the title, etc. of the file currently playing back on the iPod on this unit's display

- Press the MODE button to set "On-Display" mode. (👉 p. 38)

I want to playback WAV files

- This unit can playback WAV files that are stored on a USB memory device. (👉 p. 40)

I want to use this unit's remote control to operate a Marantz network audio player

- Press the REMOTE MODE NET button on the remote control unit to switch the remote control unit to the network audio player operation mode. (👉 p. 15)
- Also, refer to the instruction manual of the network audio player.



Troubleshooting



If a problem should arise, first check the following.

1. **Are the connections correct?**
2. **Is the set being operated as described in the owner's manual?**
3. **Are the other devices operating properly?**

If this unit does not operate properly, check the items listed in the table below.

Should the problem persist, there may be a malfunction. In this case, disconnect the power immediately and contact your store of purchase.

■ Power does not turn on / Power is turned off

Symptom	Cause / Solution	Page
Power is not turned on.	• Check whether the power plug is correctly inserted into the power outlet.	24
	• This unit is in standby mode. Press the  button on the unit or POWER  button on the remote control.	26
Power automatically turns off.	• The Auto Standby mode is set. The Auto Standby mode switches the unit to standby mode when the unit is not operated for approximately 30 minutes. To disable Auto Standby mode, set "Auto Standby" on the menu to "Off".	47



■ Operations cannot be performed through the remote control unit

Symptom	Cause / Solution	Page
Operations cannot be performed through the remote control unit.	• Batteries are worn out. Replace with new batteries.	<u>5</u>
	• Operate the remote control unit within a distance of about 7 m from this unit and at an angle of within 30°.	<u>5</u>
	• Remove any obstacle between this unit and the remote control unit.	—
	• Insert the batteries in the proper direction, checking the ⊕ and ⊖ marks.	<u>5</u>
	• The set's remote control sensor is exposed to strong light (direct sunlight, inverter type fluorescent bulb light, etc.). Move the set to a place in which the remote control sensor will not be exposed to strong light.	—
	• When using a 3D video device, the remote control unit of this unit may not function due to effects of infrared communications between units (such as TV and glasses for 3D viewing). In this case, adjust the direction of units with the 3D communications function and their distance to ensure they do not affect operations from the remote control unit of this unit.	—
	• Press the REMOTE MODE CD button to switch the remote control operating mode to "CD".	<u>11</u>
• When using this unit independently, set the switch to "INTERNAL".	<u>22</u>	

■ Display on this unit shows nothing

Symptom	Cause / Solution	Page
Display is off.	• Press the DIMMER button, and change the setting to anything other than off.	<u>27</u>



■ No sound comes out

Symptom	Cause / Solution	Page
No sound is produced. Or sound is distorted.	• Check the connections for all devices.	17
	• Insert connection cables all the way in.	—
	• Check that input connectors and output connectors are not reversely connected.	—
	• Check cables for damage.	—
	• Check the amplifier's functions and controls and adjust as necessary.	—
	• When connecting to a device with digital audio input connectors, set "Digital Out" to "On".	45

■ Sound is interrupted or noise occurs

Symptom	Cause / Solution	Page
During playback from the USB memory device, sound is occasionally interrupted.	• When the transfer speed of the USB memory device is slow, sound may occasionally be interrupted.	—

■ Desired sound does not come out

Symptom	Cause / Solution	Page
Headphone volume is low.	• Switch "H/P AMP Gain" to "MIDDLE" or "HIGH" if using headphones with high impedance or low sensitivity.	45



■ Cannot playback Discs

Symptom	Cause / Solution	Page
Cannot playback when the play button is pressed, or cannot correctly play back a specific part of the disc.	<ul style="list-style-type: none"> The disc is dirty or scratched. Either clean the disc, or insert a different disc. 	<u>60</u>
Cannot playback CD-R/CD-RW.	<ul style="list-style-type: none"> Discs cannot be played back unless they have been finalized. Use a finalized disc. 	<u>55</u>
	<ul style="list-style-type: none"> This may be caused by poor recording conditions, or the disc itself may be of poor quality. Use a correctly recorded disc. 	—
	<ul style="list-style-type: none"> The DATA CD playback function of this unit only supports playback of MP3, WMA and AAC files. 	<u>56</u>
“No Disc” is displayed.	<ul style="list-style-type: none"> “No Disc” is displayed if the disc is loaded upside-down or if no disc is loaded. 	<u>59</u>
“Unsupported” is displayed.	<ul style="list-style-type: none"> “Unsupported” is displayed if a disc that cannot be played is loaded. 	<u>59</u>

■ iPod cannot be played back

Symptom	Cause / Solution	Page
iPod cannot be connected.	<ul style="list-style-type: none"> When using iPod by connecting it to the USB port, some iPod variations are not supported. 	<u>20</u>
	<ul style="list-style-type: none"> When iPod is connected by using a USB cable other than the genuine cable, iPod may not be recognized. Use a genuine USB cable. 	—



■ USB memory devices cannot be played back

Symptom	Cause / Solution	Page
"No Device" is displayed.	<ul style="list-style-type: none"> This unit may not recognize the USB memory device due to poor connection, etc. Make sure that the connection is made properly by taking actions such as disconnecting and reconnecting the USB memory device. 	<u>20</u>
	<ul style="list-style-type: none"> Mass storage class compatible USB memory devices are supported. 	—
	<ul style="list-style-type: none"> This unit does not support a connection through a USB hub. Connect the USB memory device directly to the USB port. 	—
	<ul style="list-style-type: none"> The USB memory device must be formatted to FAT16 or FAT32. 	—
	<ul style="list-style-type: none"> Not all USB memory devices are guaranteed to work. Some USB memory devices are not recognized. When using a type of portable hard disc drive compatible with the USB connection that requires power from an AC adapter, use the AC adapter that came with the drive. 	—
Files on the USB memory device are not displayed.	<ul style="list-style-type: none"> Files of a type not supported by this unit are not displayed. 	<u>57</u>
	<ul style="list-style-type: none"> This unit can display a file structure with up to 8 levels, up to 700 folders and up to 65,535 files in total. Modify the folder structure of the USB memory device. 	—
	<ul style="list-style-type: none"> When multiple partitions exist on the USB memory device, only files on the first partition are displayed. 	—
Files on a USB memory device cannot be played.	<ul style="list-style-type: none"> Files are created in a format that is not supported by this unit. Check the formats supported by this unit. 	<u>57</u>
	<ul style="list-style-type: none"> Files that are copyright protected cannot be played on this unit. 	—



■ File names on the iPod/USB memory device are not displayed properly

Symptom	Cause / Solution	Page
The file names are not displayed properly ("...", etc.).	<ul style="list-style-type: none"> Characters that cannot be displayed have been used. On this unit, characters that cannot be displayed are replaced with a "." (period). 	—



Playable media

Discs

Playable media	
CD	
CD-R	
CD-RW	

NOTE

- Some discs and some recording formats may not be playable.
- Non-finalized discs cannot be played.

Files

CD-R and CD-RW discs created in the format described below can be played.

■ Writing software format

ISO9660 level 1, 2

Expansion format (Juliet.Romeo)

- When written in other formats, it may not be possible to play the disc properly.

■ Maximum number of playable files and folders

Number of folders : 255

Number of files : 255

■ Tag data

ID3-TAG (Ver.1.x and 2.x)

WMA-TAG

AAC-TAG

(The title, artist, and album tag data are supported)



Compatible formats

	Sampling frequency	Bit rate	Bit length	Extension
WMA *	32/44.1/48 kHz	32 – 192 kbps	–	.wma
MP3	32/44.1/48 kHz	32 – 320 kbps	–	.mp3
AAC *	32/44.1/48 kHz	32 – 320 kbps	–	.m4a

* Only files that are not protected by copyright can be played on this unit. Content downloaded from pay sites on the Internet are copyright protected. Also, files encoded in WMA format when ripped from a CD, etc., on a computer may be copyright protected, depending on the computer's settings.



- When audio from files in the disc is output from the digital audio output connector, the sampling frequency is converted to 44.1 kHz for output.

NOTE

- Be sure to give files the extension. Files with any other extensions or files with no extensions cannot be played.
- Recordings you have made should only be used for your personal enjoyment, and as per copyright laws may not be used in other ways without permission of the copyright holder.

USB memory device

USB-compatible file systems

FAT16 or FAT32

- If the USB memory device is divided into multiple partitions, only the top drive can be selected.

Maximum number of playable files and folders

Maximum number of files : 65,535

Maximum number of folders : 700

Tag data

ID3-TAG (Ver.1.x and 2.x)

WMA-TAG

AAC-TAG

(The title, artist, and album tag data are supported)



Compatible formats

	Sampling frequency	Bit rate	Bit length	Extension
WMA *	32/44.1/48 kHz	32 – 320 kbps	–	.wma
MP3	32/44.1/48 kHz	32 – 320 kbps	–	.mp3
WAV	32/44.1/48 kHz	–	16 bit	.wav
AAC *	32/44.1/48 kHz	32 – 320 kbps	–	.m4a

* Only files that are not protected by copyright can be played on this unit. Content downloaded from pay sites on the Internet are copyright protected. Also, files encoded in WMA format when ripped from a CD, etc., on a computer may be copyright protected, depending on the computer's settings.



- When audio from files in the USB memory device is output from the digital audio output connector, the sampling frequency is converted to 44.1 kHz for output.

NOTE

- Be sure to give files the extension. Files with any other extensions or files with no extensions cannot be played.
- Recordings you have made should only be used for your personal enjoyment, and as per copyright laws may not be used in other ways without permission of the copyright holder.
- Insert and remove a USB memory device with the power set to standby. If it is inserted or removed with the power on, the recorded files cannot be loaded or may be damaged.
- It is not compatible with an MP3 player, digital camera, a USB device for a mobile phone, etc.
- The unit cannot charge a USB device.
- The unit does not support a card reader, USB extension cable, or USB hub.



Playback order of MP3/WMA/AAC/WAV files

When there are multiple folders containing MP3/WMA/AAC/WAV files, the playback order of folders is automatically set when this unit reads the media. The files in each folder are played back in the order in which the files were recorded on the media, from the oldest date and time.

CD-R/CD-RW

For playback of files on CD-R or CD-RW, files in all folders on the first layer are played first, next on the second layer, then next on the third layer, and so on in this order.

USB memory device

For playback of files recorded on USB, files in the first folder on the first partition are played first, next folders on the second partition in the folder, then next on the third partition, and so on in this order. Then accordingly files on another first partition are played.



- The playback order displayed on a PC may differ from the actual playback order.
- The playback order with a CD-R/CD-RW may differ, depending on the writing software.

NOTE

- The playback order may differ from the order in which the folders or files were recorded if you delete or add a folder or file on USB. This occurs because of data recording specifications and is not a malfunction.

About discs and files

Files, such as MP3/WMA/AAC/WAV etc., recorded on CD-R/-RW and USB memory device are divided into large segments (folders) and small segments (files). Files are stored in folders, and folders can be placed for storage in a hierarchy. The unit can recognize up to 8 levels of folders.

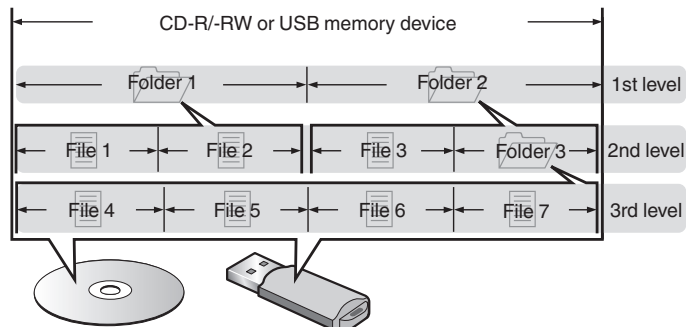

- When writing music files on a CD-R/-RW disc, set the writing software's format to "ISO9660". The files may not play properly if they are recorded in other formats. For details, refer to the instructions of your writing software.



Cautions on using media

Inserting a disc

- Set the disc in the tray label side up.
- Make sure the disc tray is fully open when inserting the disc.
- Place the discs flatly, 12 cm discs in the outer tray guide (Figure 1), 8 cm discs in the inner tray guide (Figure 2).

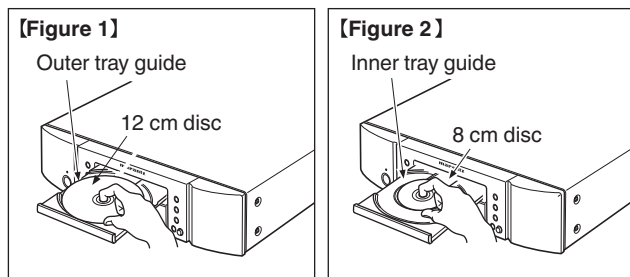

- Place 8 cm discs in the inner tray guide without using an adapter.



- "Unsupported" is displayed if a disc that cannot be played is loaded.
- "No Disc" is displayed if the disc is loaded upside-down or if no disc is loaded.

NOTE

- Only load one disc at a time. Loading two or more discs can damage the unit or scratch the discs.
- Do not use cracked or warped discs or discs that have been repaired with adhesive, etc.
- Do not use discs on which the sticky part of cellophane tape or labels is exposed or on which there are traces of where labels have been removed. Such discs can get caught inside the player and damage it.
- Do not use discs in special shapes, as they may damage the player.



- Do not push the disc tray in by hand when the power is off. Doing so could damage the set.
- If the unit is left in a room full of smoke from cigarettes, etc., for long periods of time, the surface of the optical pickup may get dirty, preventing it from receiving signals properly.



How to handle media

- Do not get fingerprints, oil or dirt on discs.
- Take special care not to scratch discs when removing them from their cases.
- Do not bend or heat discs.
- Do not enlarge the hole in the center.
- Do not write on the labeled (printed) surface with ball-point pens, pencils, etc., or stick new labels on discs.
- Condensation may form on discs if they are moved suddenly from a cold place (outdoors for example) to a warm place, but do not try to dry discs with a hairdryer, etc.
- Do not eject a USB memory device or turn off the unit while a USB memory device is being played. This may result in malfunction or loss of the USB memory device's data.
- Do not attempt to open or modify a USB memory device.
- USB memory device and files can be damaged by static electricity. Do not touch the metal contacts of a USB memory device with your fingers.
- Do not use warped USB memory device.
- After use, be sure to remove any disc or USB memory device, and store it in its proper case, to avoid dust, scratches and deformation.
- Do not store discs in the following places:
 1. Places exposed to direct sunlight for long periods of time
 2. Dusty or humid places
 3. Places exposed to heat from heaters, etc.

Cleaning discs

- If there are fingerprints or dirt on a disc, wipe them off before using the disc.
- Use a commercially available disc cleaning set or a soft cloth to clean discs.



Gently wipe the disc from the inside towards the outside.

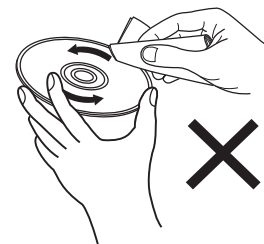

Do not wipe with a circular motion.

NOTE

- Do not use record spray, antistatic agents, benzene, thinner or other solvents.



Explanation of terms

MP3 (MPEG Audio Layer-3)

This is an internationally standardized audio data compression scheme, using the “MPEG-1” video compression standard. It compresses the data volume to about one eleventh its original size while maintaining sound quality equivalent to a music CD.

WMA (Windows Media Audio)

This is audio compression technology developed by Microsoft Corporation.

WMA data can be encoded using Windows Media® Player.

To encode WMA files, only use applications authorized by Microsoft Corporation. If you use an unauthorized application, the file may not work properly.

Sampling frequency

Sampling involves taking a reading of a sound wave (analog signal) at regular intervals and expressing the height of the wave at each reading in digitized format (producing a digital signal).

The number of readings taken in one second is called the “sampling frequency”. The larger the value, the closer the reproduced sound is to the original.

Dynamic range

The difference between the maximum undistorted sound level and the minimum discernible level above the noise emitted by the device.

Bit rate

This is the amount of audio data recorded on a disc that is read in one second.

Finalizing

This process enables CDs recorded with a CD recorder or drive to be played by other players.

Linear PCM

This is an uncompressed PCM (Pulse Code Modulation) signal. Unlike lossy compression audio sources such as MP3, no audio quality or dynamic range deteriorates.



Trademark information



"Made for iPod" and "Made for iPhone" mean that an electronic accessory has been designed to connect specifically to iPod, or iPhone, respectively, and has been certified by the developer to meet Apple performance standards.

Apple is not responsible for the operation of this device or its compliance with safety and regulatory standards. Please note that the use of this accessory with iPod, or iPhone, may affect wireless performance.

iPhone, iPod, iPod classic, iPod nano, iPod shuffle, and iPod touch are trademarks of Apple Inc., registered in the U.S. and other countries.

- Individual users are permitted to use iPhone, iPod, iPod classic, iPod nano, iPod shuffle, and iPod touch for private copy and playback of non-copyrighted contents and contents whose copy and playback is permitted by law. Copyright infringement is prohibited by law.



Adobe, the Adobe logo and Reader are either registered trademarks or trademarks of Adobe Systems Incorporated in the United States and/or other countries.



Specifications

■ Audio performance

• Analog output

Channels:	2-channels
Playable frequency range:	2 Hz – 20 kHz
Playable frequency response:	2 Hz – 20 kHz (± 0.5 dB)
S/N:	110 dB
Dynamic range:	100 dB
Harmonic distortion:	0.002 % (1 kHz)
Wow & flutter:	Crystal accuracy

• Output level

Signal type:	2.2 V RMS stereo
Headphone output:	28 mW/32 Ω /ohms (variable maximum)

• Digital output

Coaxial:	0.5 V _{p-p} / 75 Ω /ohms
Optical:	-19 dBm

• Optical readout system

Laser:	AlGaAs
Wave length:	780 nm
Signal type:	16-bit linear PCM
Sampling frequency:	44.1 kHz



■ General

Power supply:	AC 230 V, 50/60 Hz
Power consumption:	32 W
Power consumption in standby mode:	0.3 W or less
Operating temperatures:	+5 °C - +35 °C
Operating humidity:	5 – 90 % (without dew)

For the purpose of improvement, the specifications and design are subject to change without notice.



■ Dimensions (Unit : mm)

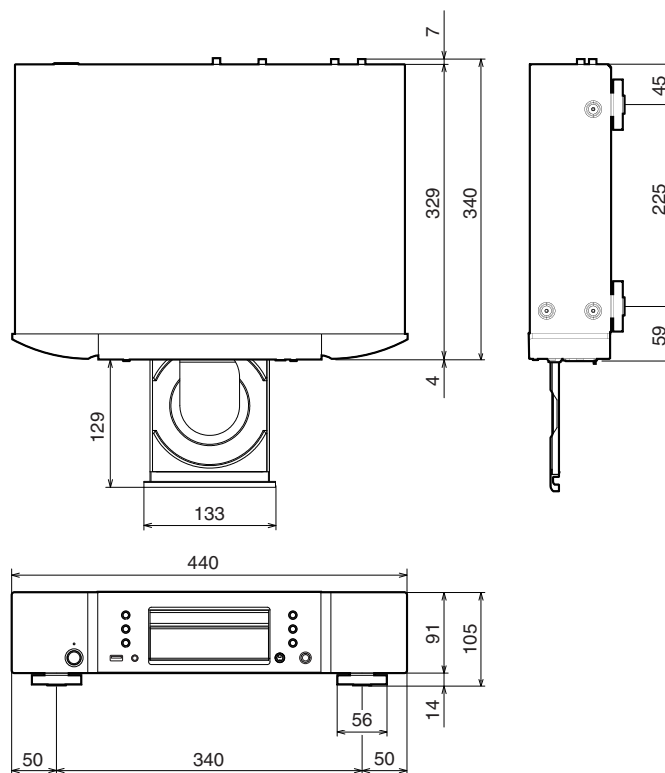

■ Weight : 6.5 kg

Index

A		F		T	
A-B repeat playback	30	Front panel	7	Timer device	23
Amplifier	18	I		Tips	49
Auto Standby	47	iPod	20, 37	Troubleshooting	50
AV receiver	19	iPod Browse Mode	38	U	
C		M		USB memory device	20, 40
CD	28, 28	Menu map	43		
CD-TEXT	33	P			
D		Program playback	30		
D/A converter	19	R			
DATA CD	34	Random playback	29, 35, 39, 41		
Delete program playback	31	Rear panel	10		
Display	9	Remote control	22		
Display brightness	27	Remote control unit	11		
		Repeat playback	29, 35, 39, 41		





www.marantz.com

You can find your nearest authorized distributor or dealer on our website.

marantz[®] is a registered trademark.

3520 10469 00AM

Copyright © 2016 D&M Holdings Inc. All Rights Reserved.